

# NARDI

YOUR OUTDOOR LIVING



OUTDOOR

**OUTDOOR**

design Raffaello Galotto

Interpretare la voglia di vivere  
all'aria aperta, proporre  
prodotti con forme e colori  
brillanti e seducenti.  
Da più di 25 anni Nardi  
rappresenta in modo  
contemporaneo le scenografie  
del vivere open air. Per star  
bene e far star bene gli altri.  
Nardi #feelingbetter

An expression of the desire  
to live life outdoors, offering  
products with bright and  
seductive shapes and colours.  
For more than 25 years, Nardi  
has been providing modern,  
open air living solutions.  
Feeling great and making  
others feel great.  
Nardi #feelingbetter

## VISIONE

Nardi è il risultato di una storia imprenditoriale che ha come cardini la cultura del progetto open air, l'attitudine all'innovazione e il design. L'azienda promuove l'incontro tra un disegno unico e la tecnologia più all'avanguardia, la qualità unita alla funzionalità e il pensiero ecologico che si realizza nella totale riciclabilità dei prodotti, nel riutilizzo degli scarti di produzione e nella progettazione di packaging eco-compatibili. Nardi distribuisce i suoi prodotti in tutto il mondo puntando a rendere unici ed accoglienti gli spazi esterni.

## VISION

Nardi is the result of an entrepreneurial story, with its roots in the culture of open air projects and a talent for innovation and design. The company brings together unique designs and the most avant-garde technology, combining quality with functionality and an environmentally-friendly approach, with completely recyclable products, recycling of manufacturing waste and the design of eco-friendly packaging. Nardi distributes its products throughout the world, with the aim of making outdoor spaces unique and welcoming.



## PRODUZIONE

Nardi realizza arredi per l'outdoor adatti ad ambienti home e collettivi, studiati per il benessere e il relax delle persone.

Il polipropilene fiber-glass di alta qualità è protagonista di tutte le collezioni che nascono da un'approfondita ricerca di design, colore e abbinamento di materiali. Ogni prodotto è realizzato in una filiera completamente Made in Italy e sottoposto a severi controlli di qualità. Ogni singola fase di processo è seguita da personale competente e valorizzato dall'azienda che pone al centro i rapporti con le persone.

## PRODUCTION

Nardi produces outdoor furniture that is suitable for homes and communal areas, designed for people to relax and unwind.

High quality, polypropylene fiberglass plays the leading role in every collection, all of which are created following extensive research into design, colour and the combination of materials. The company's production chain is entirely 'Made in Italy', with each product undergoing strict quality control checks. Every single phase of the production process is followed by expert members of staff and valued by the company, which considers solid relationships with its people as being a fundamental key to success.

**NET TABLE**  
**NET BENCH**  
**NET RELAX**





NET TABLE  
NET BENCH  
NET RELAX





NET RELAX  
NET BENCH





NET BENCH  
NET TABLE

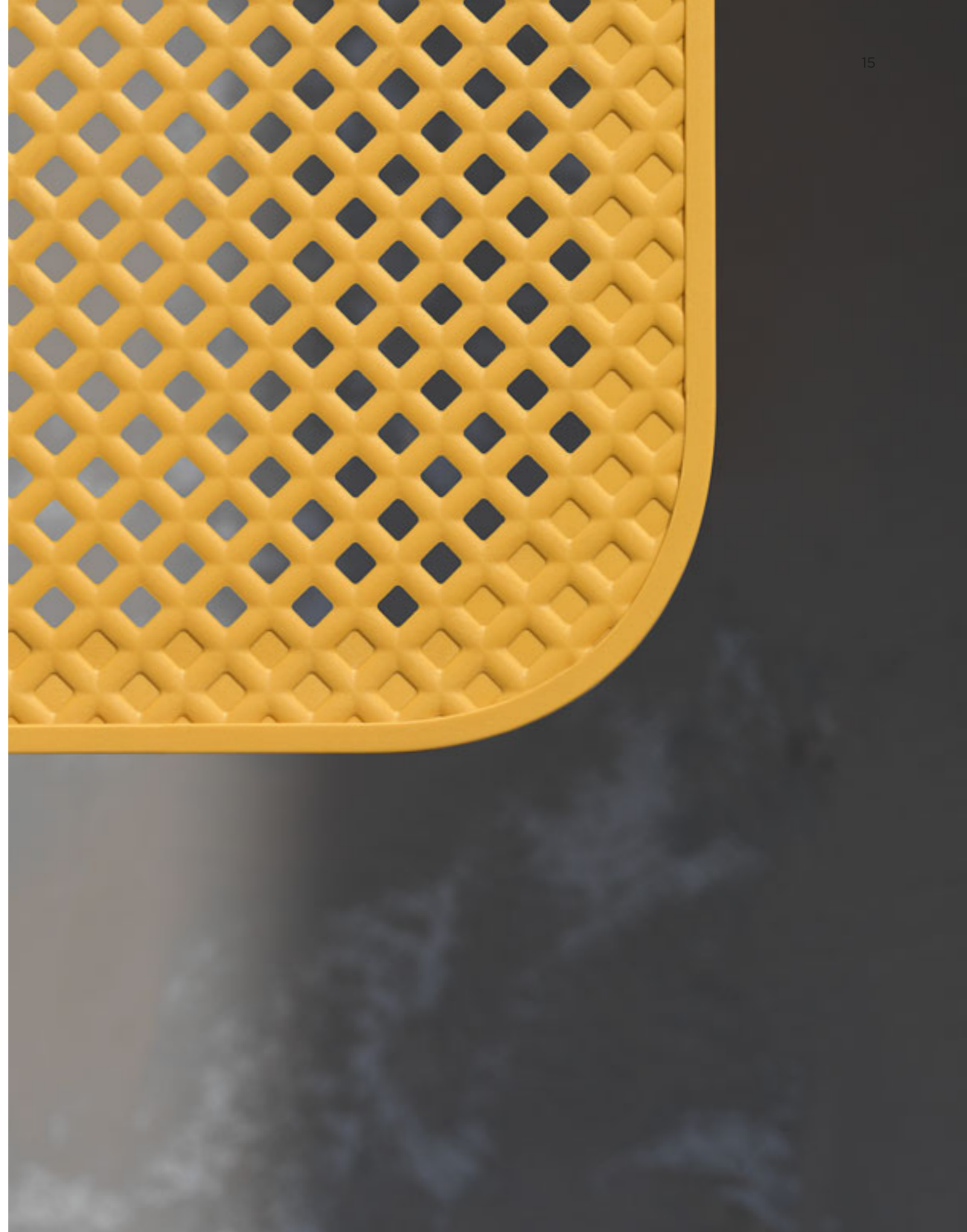





NET TABLE  
NET BENCH  
NET RELAX





NET BENCH







NET TABLE





**RIO  
NET RELAX  
NET  
BIT**





RIO 210 EXTENSIBLE  
NET RELAX





RIO 210 EXTENSIBLE  
NET RELAX





NET RELAX

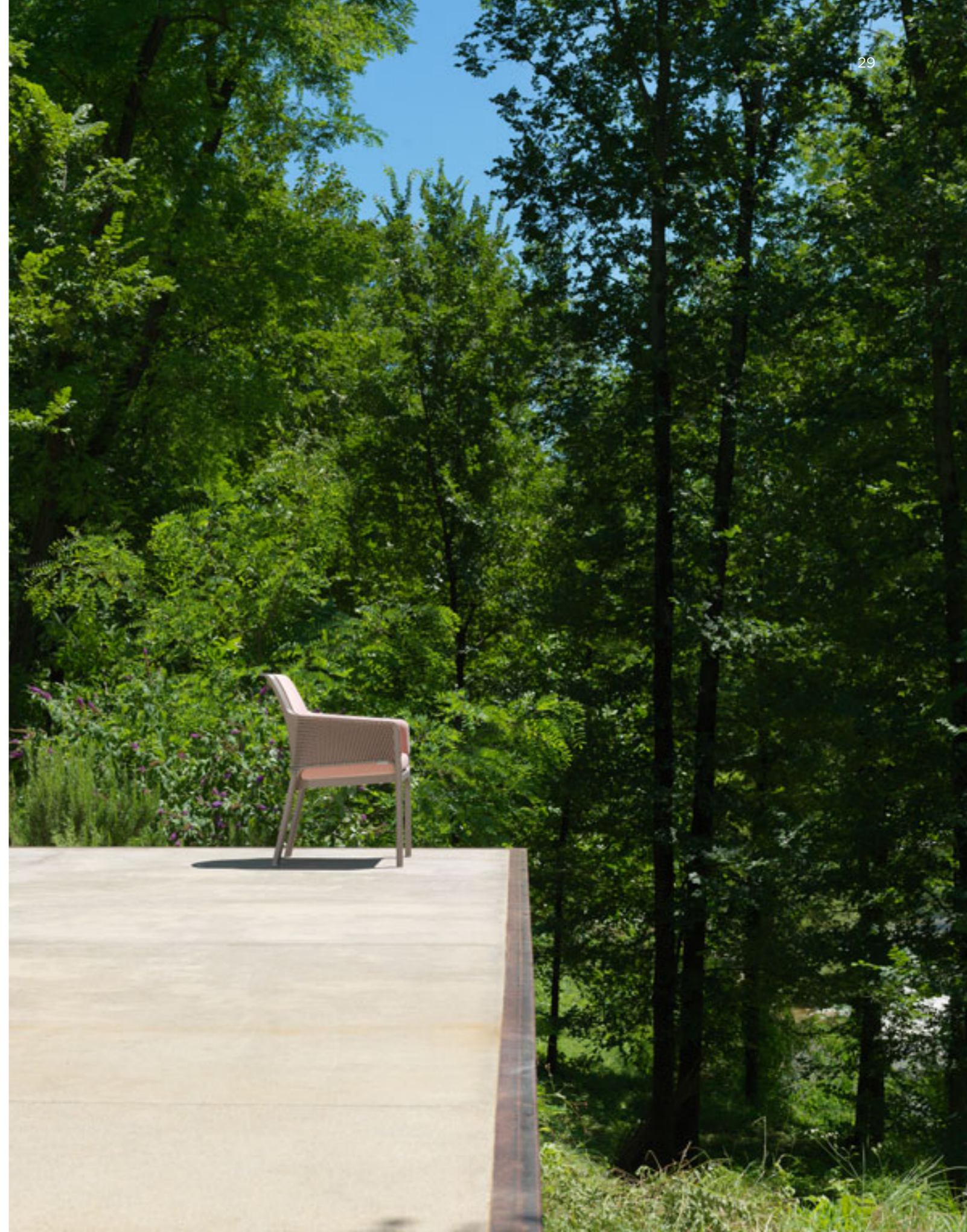





RIO 210 EXTENSIBLE  
NET RELAX





RIO 210 EXTENSIBLE  
NET RELAX





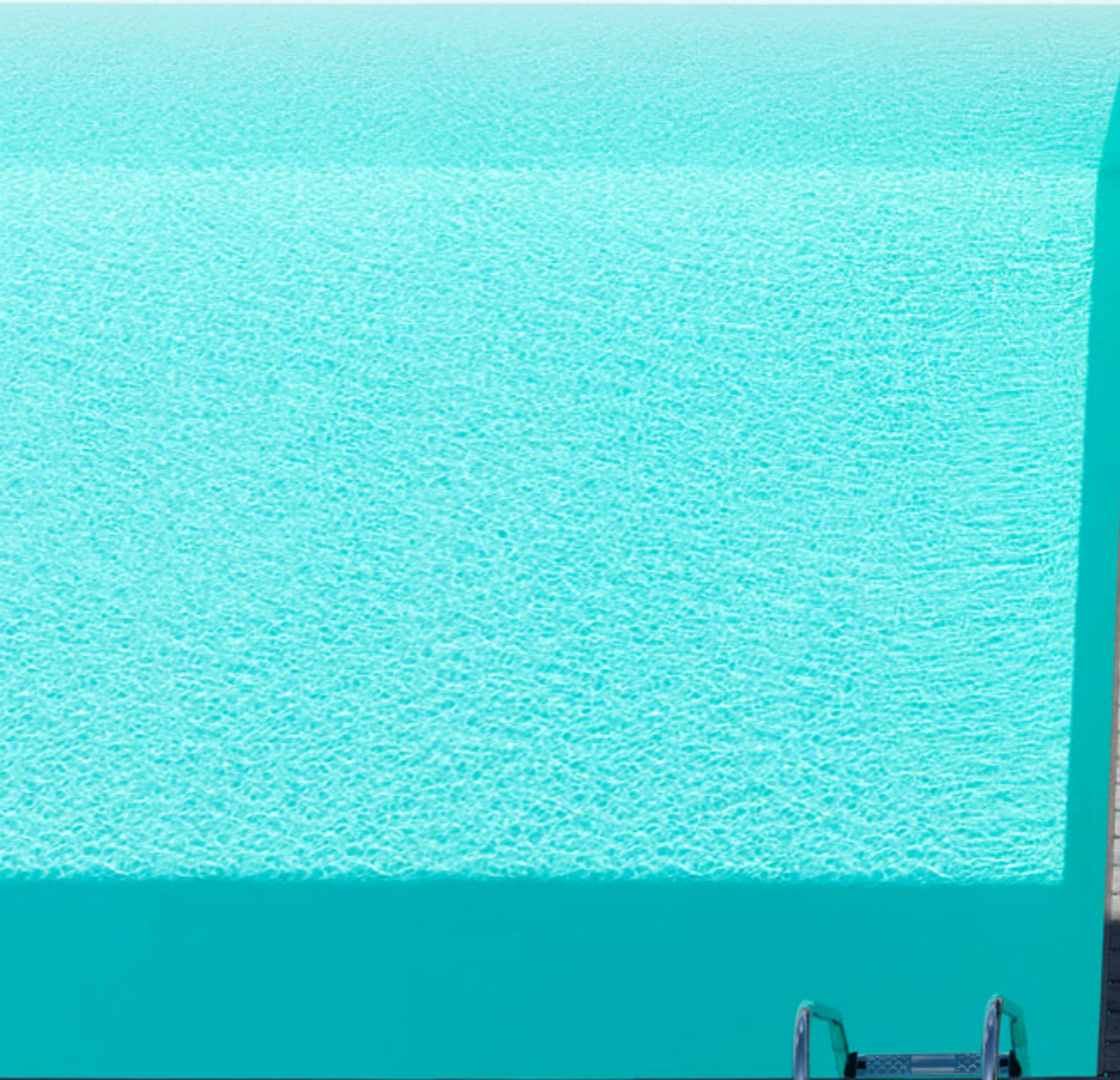

RIO 210 EXTENSIBLE  
NET







NET  
RIO 210 EXTENSIBLE

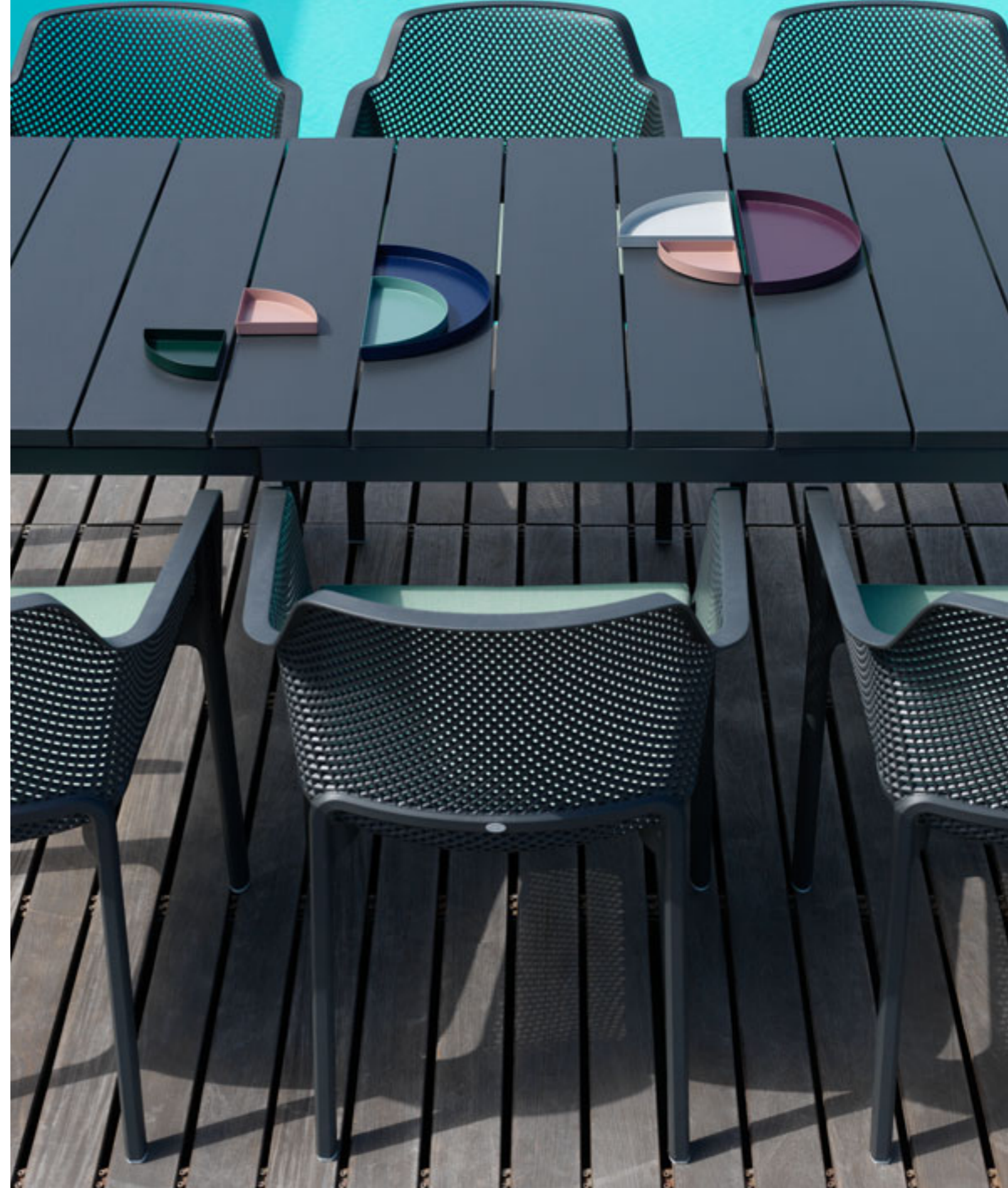





NET





RIO 140 EXTENSIBLE  
BIT





RIO 140 EXTENSIBLE  
BIT









**ALLORO  
ARIA  
PALMA**





ALLORO 210 EXTENSIBLE  
ARIA





ARIA FIT  
ALLORO 210 EXTENSIBILE











ALLORO 140 EXTENSIBLE  
PALMA





PALMA  
ALLORO 140 EXTENSIBILE



**LOTO DINNER**  
**LOTO RELAX**  
**NINFEA DINNER**  
**NINFEA RELAX**





LOTO DINNER 190  
NINFEA DINNER





LOTO DINNER 190  
NINFEA DINNER







LOTO DINNER 190  
NINFEA DINNER







LOTO RELAX 95  
NINFEA RELAX





NINFEA RELAX







LOTO RELAX 95





**ARIA TAVOLINO**  
**ARIA**





ARIA TAVOLINO 100  
ARIA







ARIA TAVOLINO 100  
ARIA







ARIA TAVOLINO 100  
ARIA



**STEP  
BORA**





STEP  
BORA





**ATLANTICO  
POP**



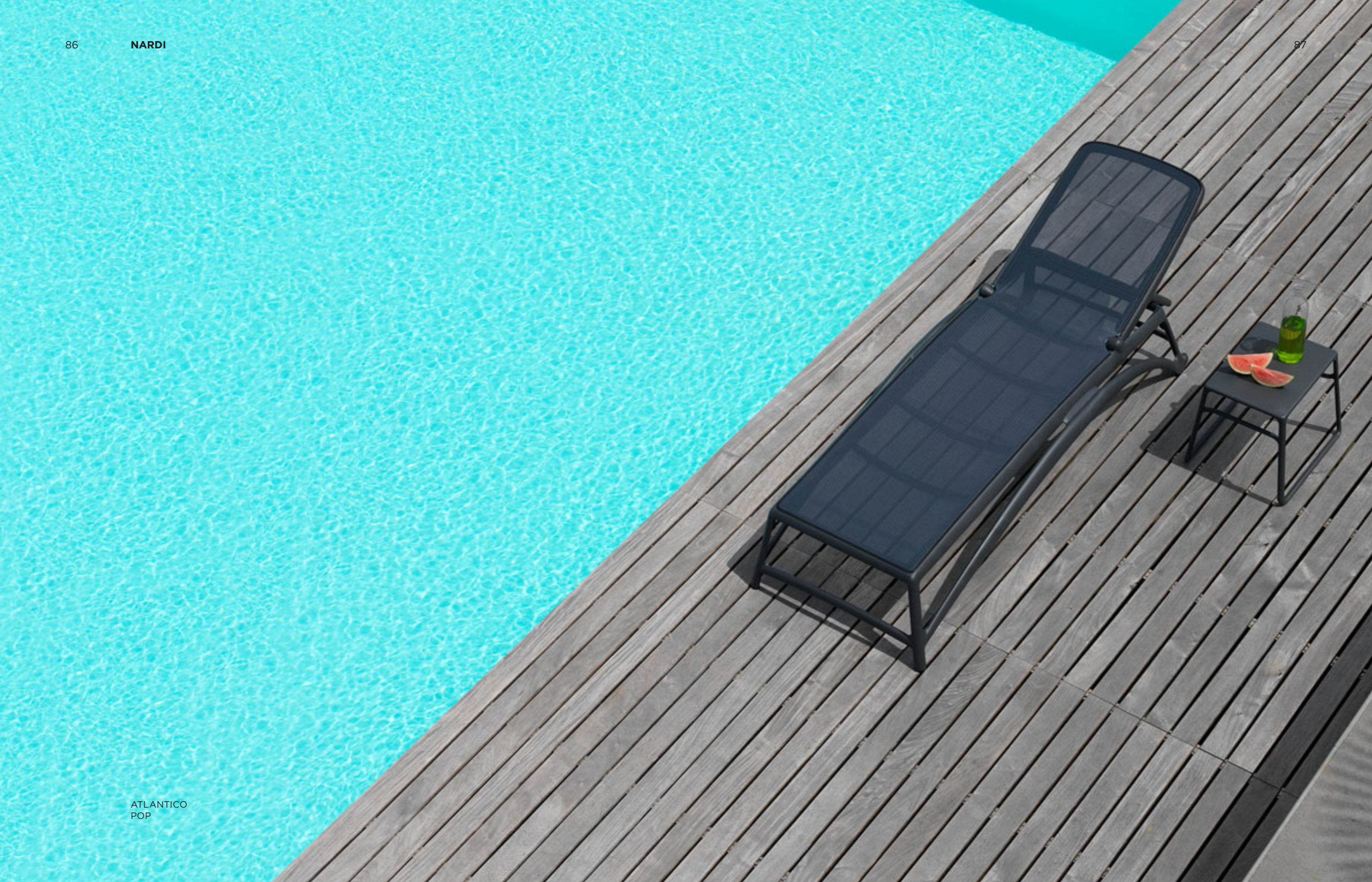





POP  
ATLANTICO







ATLANTICO













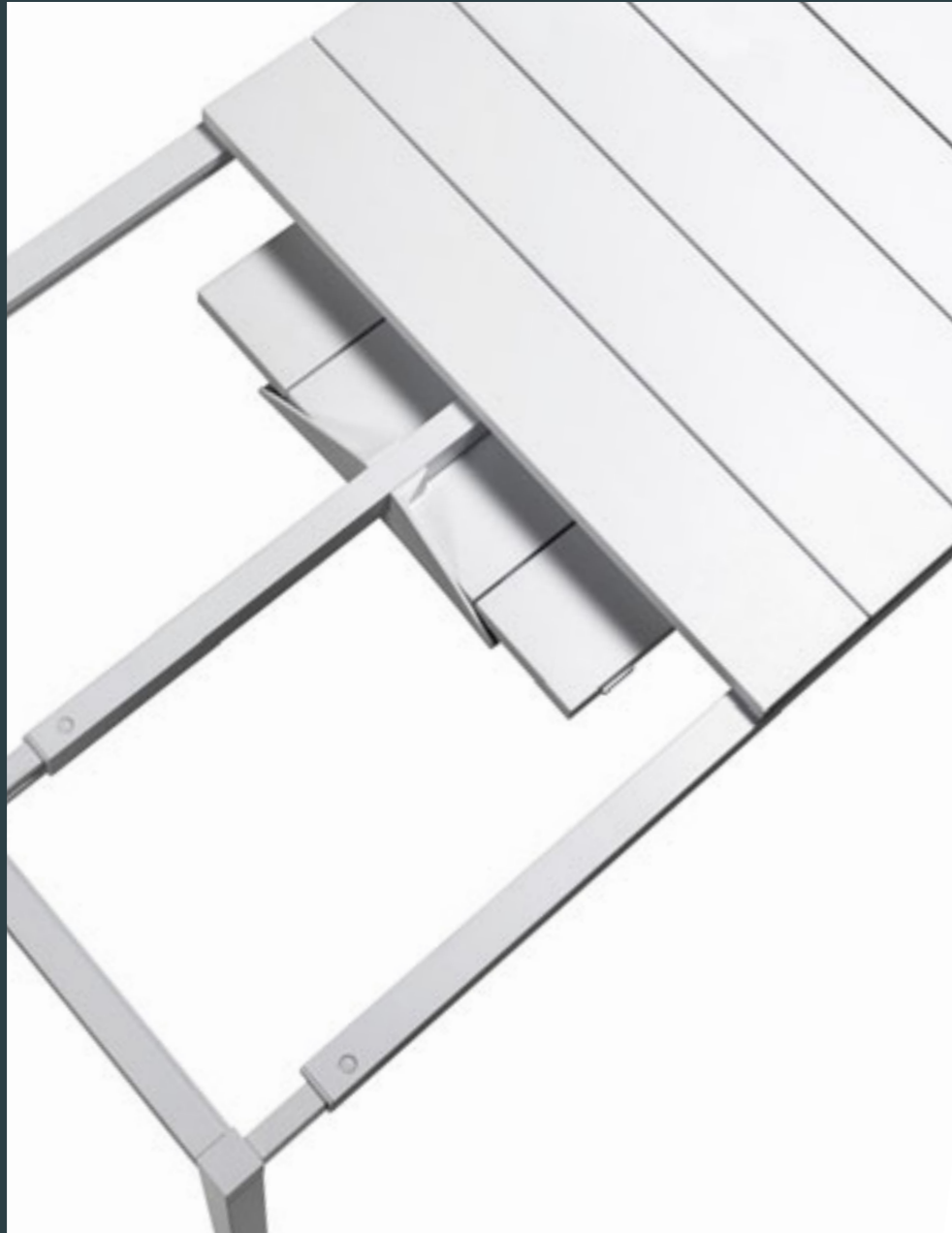

# RIO

rio 140 extensible  
6/8 🧑 140/210x85x76 cm

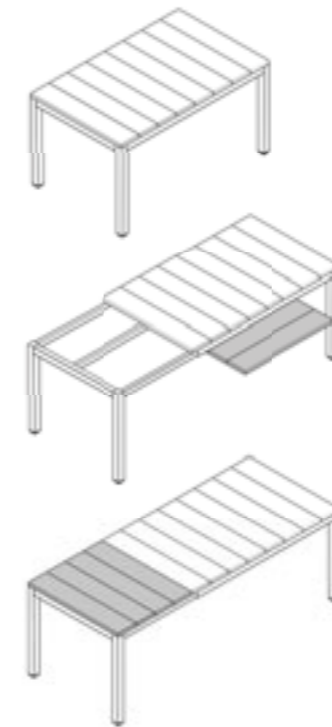

rio 210 extensible  
8/10 🧑 210/280x100x76 cm







# ALLORO

alloro 140 extensibile  
6/8 🧑 140/210x100x73 cm



alloro 210 extensibile  
8/10 🧑 210/280x100x73 cm





NET BENCH **new**

polipropilene fiberglass

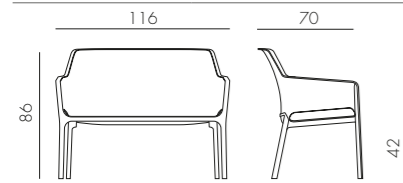
8,9 kg  
n. pz. 20 

BIANCO 40338.00.000 ANTRACITE 40338.02.000 SALICE 40338.04.000 TORTORA 40338.10.000  
SENAPE 40338.56.000 CORALLO 40338.75.000

## NET RELAX

polipropilene fiberglass

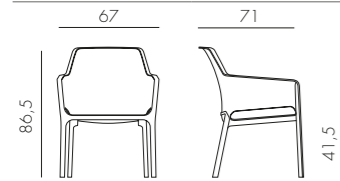
4,7 kg  
n. pz. 20 

BIANCO 40327.00.000 ANTRACITE 40327.02.000 SALICE 40327.04.000 TORTORA 40327.10.000  
SENAPE 40327.56.000 CORALLO 40327.75.000

CUSCINO NET BENCH **new**

tessuto acrilico

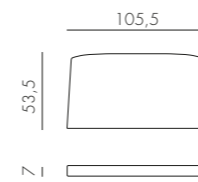
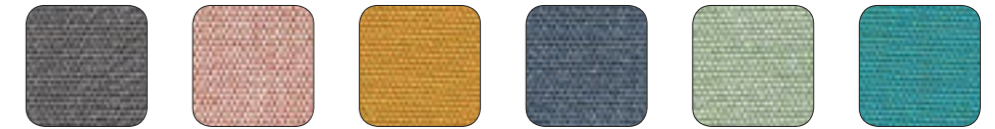
1,5 kg  
n. pz. 4

GREY STONE 36338.00.064 ROSA QUARZO 36338.00.066 SENAPE 36338.00.069 DENIM 36338.00.070  
THE VERDE 36338.00.071 SARDINIA 36338.00.072



BIANCO 36338.00.155 GRIGIO 36338.00.163 GRIGIO Sunbrella® 36338.00.136

## CUSCINO NET RELAX

tessuto acrilico

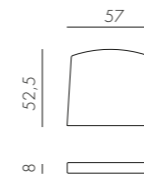
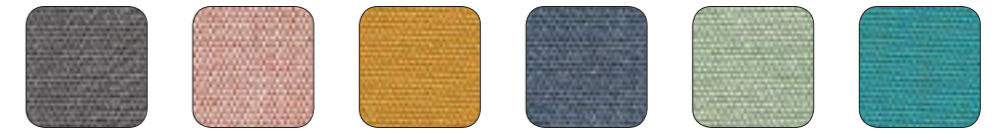
0,8 kg  
n. pz. 4

GREY STONE 36327.00.064 ROSA QUARZO 36327.00.066 SENAPE 36327.00.069 DENIM 36327.00.070  
THE VERDE 36327.00.071 SARDINIA 36327.00.072



BIANCO 36327.00.155 GRIGIO 36327.00.163 GRIGIO Sunbrella® 36327.00.136

CUSCINO SHELL (NET RELAX) **new**

tessuto acrilico

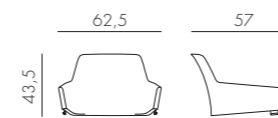
2,2 kg  
n. pz. 2

ROSA QUARZO 36327.01.066 DENIM 36327.01.070 GRIGIO 36327.01.163



## NET

polipropilene fiberglass

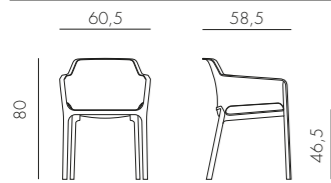

4,1 kg  
n. pz. 22



BIANCO 40326.00.000 ANTRACITE 40326.02.000 SALICE 40326.04.000 TORTORA 40326.10.000 SENAPE 40326.56.000 CORALLO 40326.75.000

BIT **new**

polipropilene fiberglass

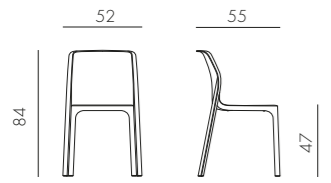

3,5 kg  
n. pz. 24



BIANCO 40328.00.000 ANTRACITE 40328.02.000 SALICE 40328.04.000 TORTORA 40328.10.000 SENAPE 40328.56.000 CORALLO 40328.75.000

## CUSCINO NET

tessuto acrilico



0,3 kg  
n. pz. 4

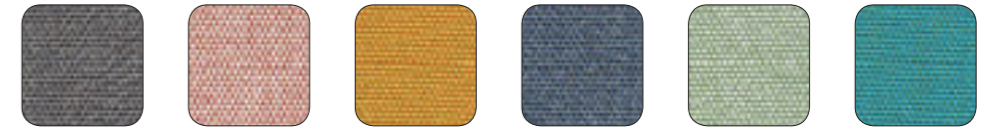

GREY STONE 36326.00.064 ROSA QUARZO 36326.00.066 SENAPE 36326.00.069 DENIM 36326.00.070 THE VERDE 36326.00.071 SARDINIA 36326.00.072



BIANCO 36326.00.155 GRIGIO 36326.00.163 GRIGIO Sunbrella® 36326.00.136

CUSCINO PASSPARTOUT **new**

tessuto acrilico

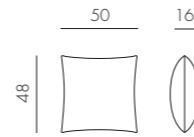

0,7 kg  
n. pz. 4

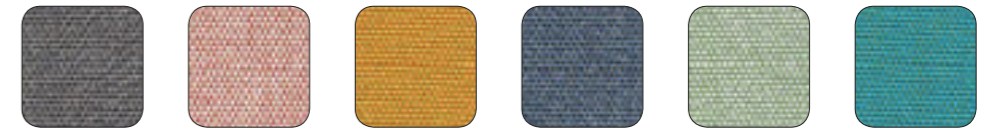

GREY STONE 36000.01.064 ROSA QUARZO 36000.01.066 SENAPE 36000.01.069 DENIM 36000.01.070 THE VERDE 36000.01.071 SARDINIA 36000.01.072

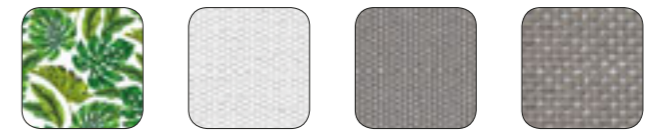

TROPICAL 36000.01.081 BIANCO 36000.01.155 GRIGIO 36000.01.163 GRIGIO Sunbrella® 36000.01.136



## BORA

polipropilene fiberglass

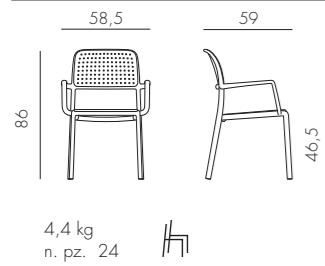

## COSTA

polipropilene fiberglass

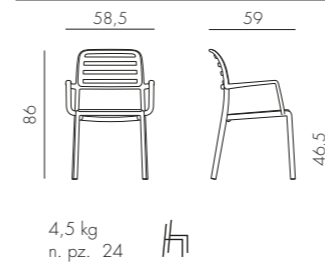

## BORA BISTROT

polipropilene fiberglass

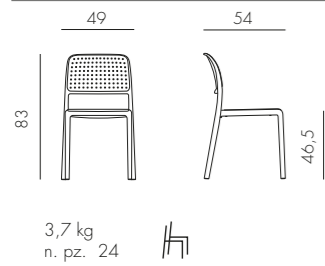

## COSTA BISTROT

polipropilene fiberglass

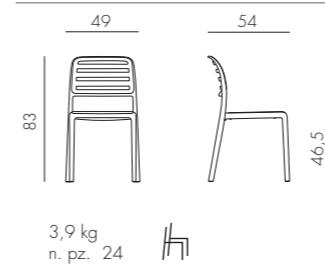

## RIVA

polipropilene fiberglass

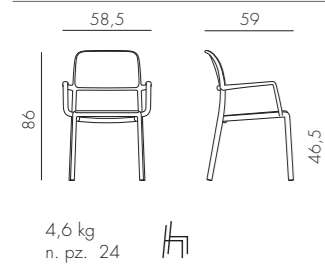

## PALMA

polipropilene

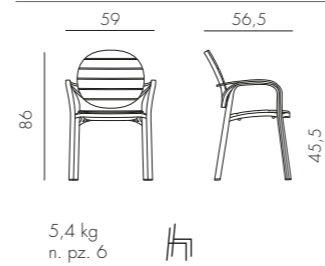

## RIVA BISTROT

polipropilene fiberglass

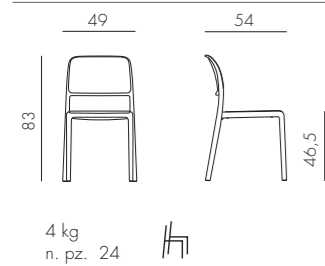

## ERICA

polipropilene

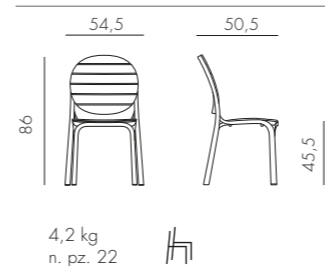



## NINFEA DINNER \*

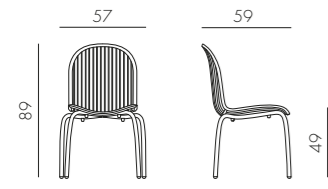

4,5 kg  
n. pz. 6



ANTRACITE  
vernici. antracite  
62052.02.000

BIANCO  
vernici. bianco  
62053.00.000

polipropilene  
alluminio

## NINFEA RELAX \*

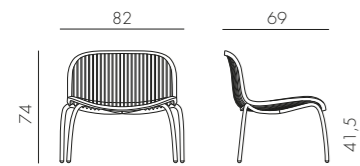

7,2 kg  
n. pz. 2



ANTRACITE  
vernici. antracite  
62252.02.000

BIANCO  
vernici. bianco  
62253.00.000

polipropilene  
alluminio

\* nuova versione  
new version

## ARIA (POLTRONA ARIA + CUSCINO SEDUTA + CUSCINO ARREDO)

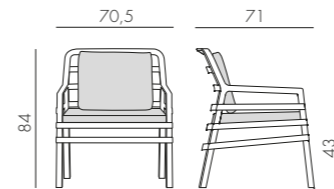

7,9 kg  
n. pz. 1

polipropilene  
tessuto acrilico

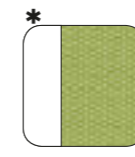

BIANCO  
lime  
40330.00.061.061



ANTRACITE  
lime  
40330.02.061.061

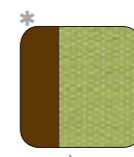

CAFFÈ  
lime  
40330.05.061.061

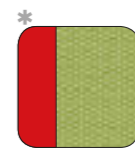

ROSSO  
lime  
40330.07.061.061

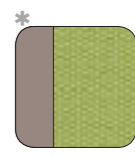

TORTORA  
lime  
40330.10.061.061

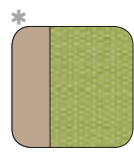

AVANA  
lime  
40330.33.061.061

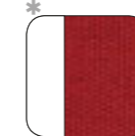

BIANCO  
cherry  
40330.00.065.065



ANTRACITE  
cherry  
40330.02.065.065



CAFFÈ  
cherry  
40330.05.065.065



ROSSO  
cherry  
40330.07.065.065



TORTORA  
cherry  
40330.10.065.065



AVANA  
cherry  
40330.33.065.065

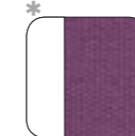

BIANCO  
melanzana  
40330.00.068.068



ANTRACITE  
melanzana  
40330.02.068.068



CAFFÈ  
melanzana  
40330.05.068.068



ROSSO  
melanzana  
40330.07.068.068

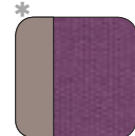

TORTORA  
melanzana  
40330.10.068.068

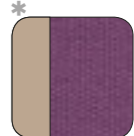

AVANA  
melanzana  
40330.33.068.068

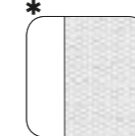

BIANCO  
bianco  
40330.00.155.155



ANTRACITE  
bianco  
40330.02.155.155

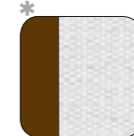

CAFFÈ  
bianco  
40330.05.155.155



ROSSO  
bianco  
40330.07.155.155

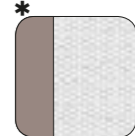

TORTORA  
bianco  
40330.10.155.155

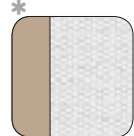

AVANA  
bianco  
40330.33.155.155



BIANCO  
caffè  
40330.00.165.165



ANTRACITE  
caffè  
40330.02.165.165



CAFFÈ  
caffè  
40330.05.165.165



ROSSO  
caffè  
40330.07.165.165



TORTORA  
caffè  
40330.10.165.165



AVANA  
caffè  
40330.33.165.165

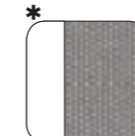

BIANCO  
grigio  
40330.00.163.163



ANTRACITE  
grigio  
40330.02.163.163

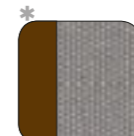

CAFFÈ  
grigio  
40330.05.163.163

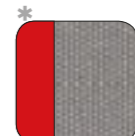

ROSSO  
grigio  
40330.07.163.163

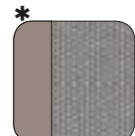

TORTORA  
grigio  
40330.10.163.163

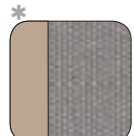

AVANA  
grigio  
40330.33.163.163

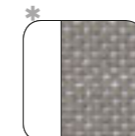

BIANCO  
grigio Sunbrella®  
40330.00.136.136



ANTRACITE  
grigio Sunbrella®  
40330.02.136.136



CAFFÈ  
grigio Sunbrella®  
40330.05.136.136



ROSSO  
grigio Sunbrella®  
40330.07.136.136

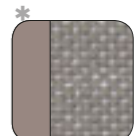

TORTORA  
grigio Sunbrella®  
40330.10.136.136

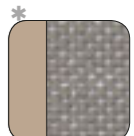

AVANA  
grigio Sunbrella®  
40330.33.136.136

\* Disponibile a magazzino  
Available ex-stock  
Disponible sur stock  
Ab Lager verfügbar  
Disponible en almacén  
habitualmente  
Disponível em estoque  
Наличие на складе

\* Disponibile su ordine  
Available to order  
Disponible sur commande  
Mit Auftrag verfügbar  
Disponible sólo sobre pedido  
Disponível sob encomenda  
Под заказ

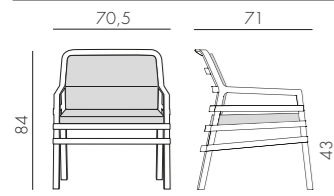

**ARIA FIT** (POLTRONA ARIA + CUSCINO SEDUTA + CUSCINO FIT) \*
polipropilene  
tessuto acrilico7,9 kg  
n. pz. 1

BIANCO bianco 40330.00.155.FIT	ANTRACITE bianco 40330.02.155.FIT	CAFFÈ bianco 40330.05.155.FIT	ROSSO bianco 40330.07.155.FIT	TORTORA bianco 40330.10.155.FIT	AVANA bianco 40330.33.155.FIT
BIANCO caffè 40330.00.165.FIT	ANTRACITE caffè 40330.02.165.FIT	CAFFÈ caffè 40330.05.165.FIT	ROSSO caffè 40330.07.165.FIT	TORTORA caffè 40330.10.165.FIT	AVANA caffè 40330.33.165.FIT
BIANCO grigio 40330.00.163.FIT	ANTRACITE grigio 40330.02.163.FIT	CAFFÈ grigio 40330.05.163.FIT	ROSSO grigio 40330.07.163.FIT	TORTORA grigio 40330.10.163.FIT	AVANA grigio 40330.33.163.FIT
BIANCO grigio Sunbrella® 40330.00.136.FIT	ANTRACITE grigio Sunbrella® 40330.02.136.FIT	CAFFÈ grigio Sunbrella® 40330.05.136.FIT	ROSSO grigio Sunbrella® 40330.07.136.FIT	TORTORA grigio Sunbrella® 40330.10.136.FIT	AVANA grigio Sunbrella® 40330.33.136.FIT

\* Disponibile su ordine  
Available to order  
Disponible sur commande  
Mit Auftrag verfügbar  
Disponibile sólo sobre pedido  
Disponível sob encomenda  
Под заказ

**CUSCINO SEDUTA ARIA** \*

tessuto acrilico

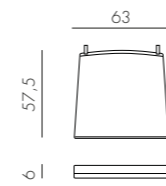
0,8 kg  
n. pz. 4

lime 36330.00.061	cherry 36330.00.065	melanzana 36330.00.068	bianco 36330.00.155	caffè 36330.00.165	grigio 36330.00.163
grigio Sunbrella® 36330.00.136					

**CUSCINO ARREDO ARIA**

tessuto acrilico

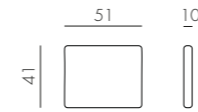
0,5 kg  
n. pz. 4

lime 36330.01.061	cherry 36330.01.065	melanzana 36330.01.068	bianco 36330.01.155	caffè 36330.01.165	grigio 36330.01.163
grigio Sunbrella® 36330.01.136					

**CUSCINO FIT ARIA** new

tessuto acrilico

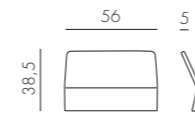
0,5 kg  
n. pz. 4

bianco 36330.04.155	caffè 36330.04.165	grigio 36330.04.163	grigio Sunbrella® 36330.04.136

\* nuova versione  
new version

\* nuova versione  
new version

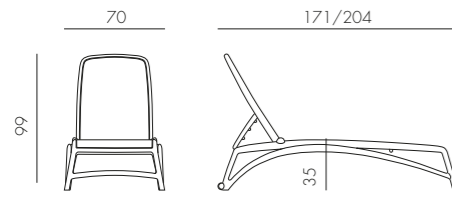

## ATLANTICO

polipropilene fiberglass  
tessuto sintetico 1 x 11,6 kg  
n. pz. 20

Tessuto ricambiabile  
Replaceable fabric  
Tissu changeable  
Auswechselbarer Stoff  
Tela sustituible  
Tecidos recambiáveis  
Değiştirilebilen Kumaş  
Съемная ткань

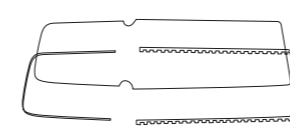
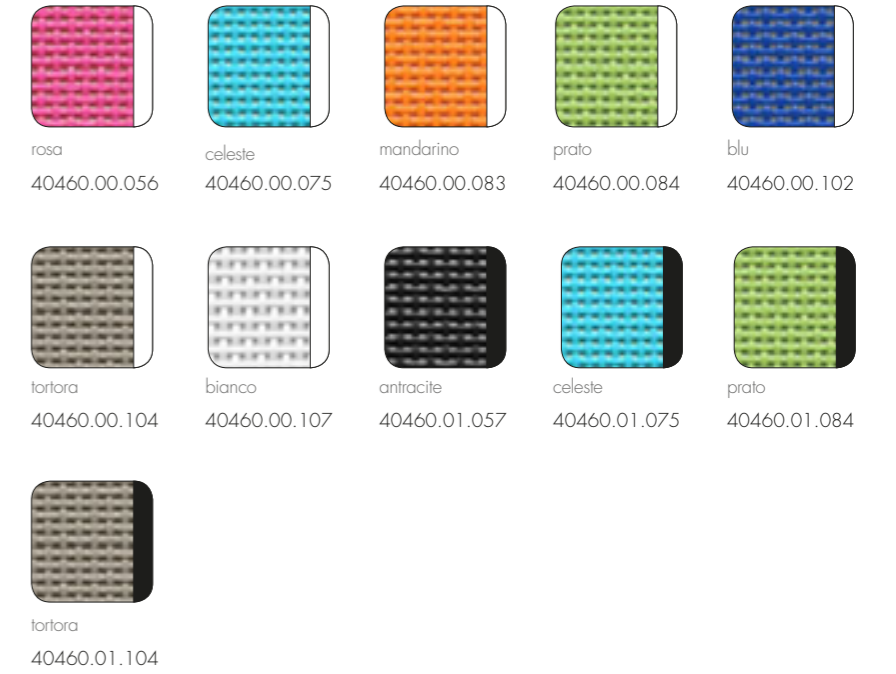

## RICAMBIO atlantico

polipropilene  
tessuto sintetico 1 x 11,3 kg  
n. pz. 1

## BRACCIOLO ATLANTICO

polipropilene fiberglass

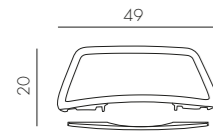
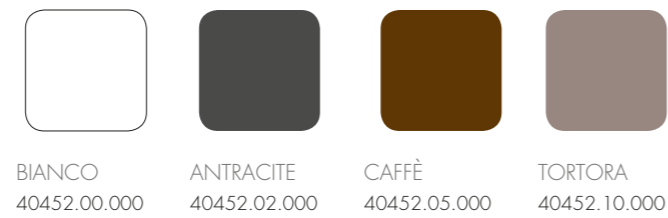
1,1 kg  
n. pz. 1

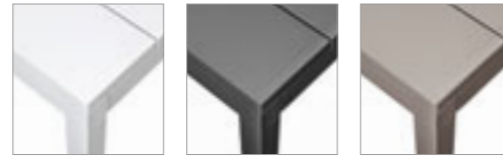
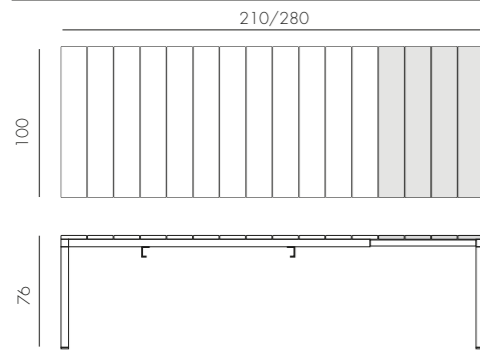

## RIO 210 EXTENSIBLE 8/10

durelTOP - polipropilene  
alluminio

BIANCO  
verniciato bianco  
48253.00.000

ANTRACITE  
verniciato antracite  
48252.02.000

TORTORA  
verniciato tortora  
48259.10.000

49 kg  
n. pz. 1

## RIO 140 EXTENSIBLE 6/8

new

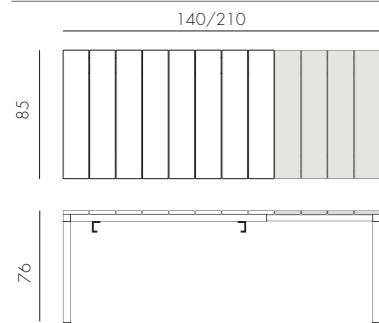
durelTOP - polipropilene  
alluminio

BIANCO  
verniciato bianco  
48353.00.000

ANTRACITE  
verniciato antracite  
48352.02.000

TORTORA  
verniciato tortora  
48359.10.000

32,6 kg  
n. pz. 1

## ALLORO 210 EXTENSIBLE 8/10

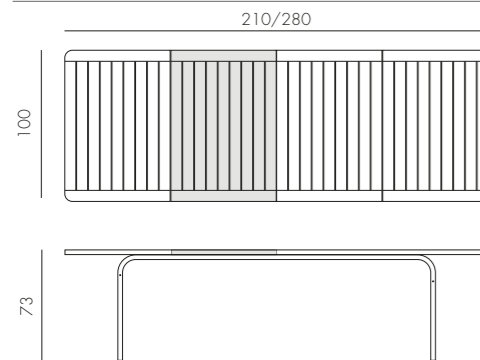
durelTOP - polipropilene  
alluminio

BIANCO  
verniciato bianco  
42853.00.000

TORTORA  
verniciato bianco  
42853.10.000

ANTRACITE  
verniciato antracite  
42852.02.000

CAFFÈ  
verniciato caffè  
42857.05.000

TORTORA  
verniciato tortora  
42859.10.000

44,4 kg  
n. pz. 1

## ALLORO 140 EXTENSIBLE 6/8

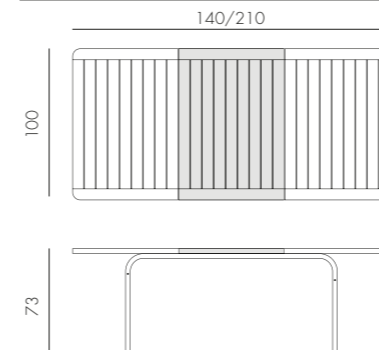
durelTOP - polipropilene  
alluminio

BIANCO  
verniciato bianco  
42753.00.000

TORTORA  
verniciato bianco  
42753.10.000

ANTRACITE  
verniciato antracite  
42752.02.000

CAFFÈ  
verniciato caffè  
42757.05.000

TORTORA  
verniciato tortora  
42759.10.000

33,7 kg  
n. pz. 1

## LOTO DINNER 190 \*

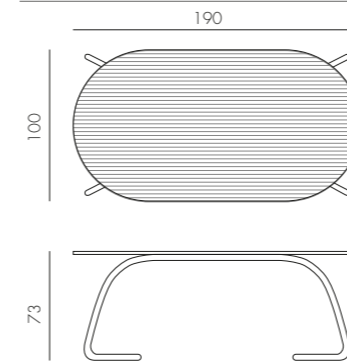
vetro  
alluminio

ANTRACITE  
verniciato antracite  
44052.02.000

BIANCO  
verniciato bianco  
44053.00.000

49,8 kg  
n. pz. 1

## LOTO DINNER Ø170 \*

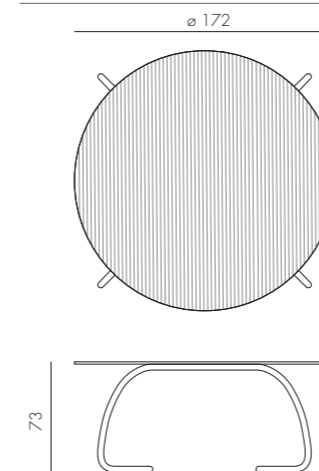
vetro  
alluminio

ANTRACITE  
verniciato antracite  
44452.02.000

BIANCO  
verniciato bianco  
44453.00.000

65,3 kg  
n. pz. 1\* nuova versione  
new version

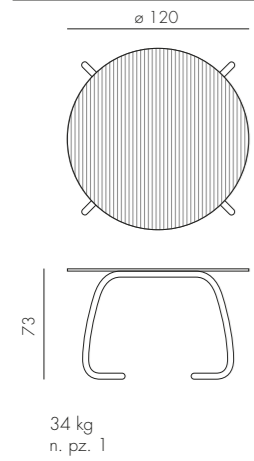

**LOTO DINNER Ø120 \***

 vetro  
alluminio

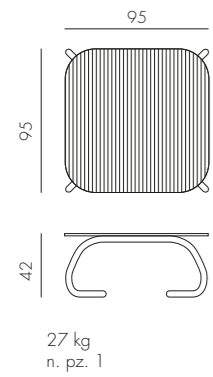
**LOTO RELAX 95 \***

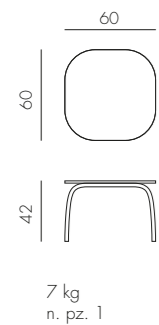
 vetro  
alluminio

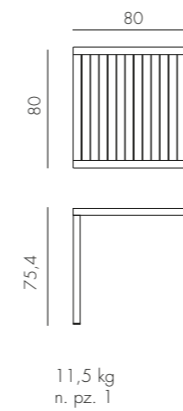
**LOTO RELAX 60 \***

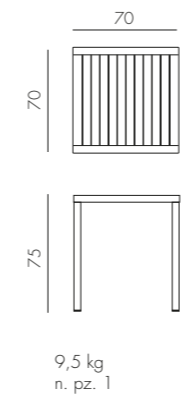
 laminato  
alluminio

**CUBE 80**

 duralTOP - polipropilene  
alluminio

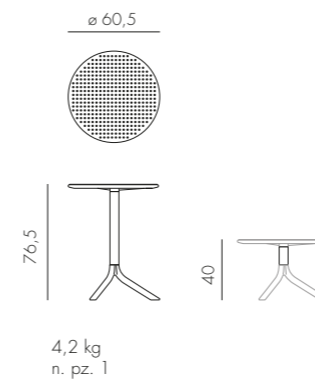
**CUBE 70 new**

 duralTOP - polipropilene  
alluminio

**STEP**

polipropilene fiberglass





## SPRITZ

polipropilene fiberglass

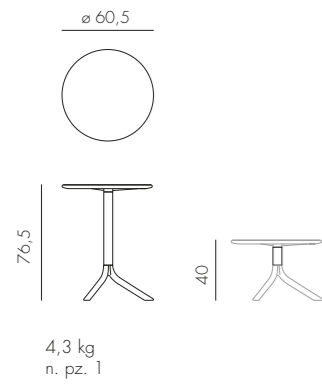
NET TABLE 100 **new**

polipropilene fiberglass

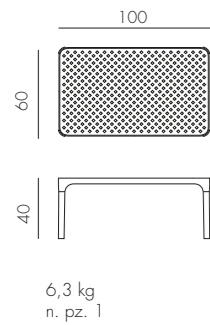

## ARIA TAVOLINO 100

polipropilene

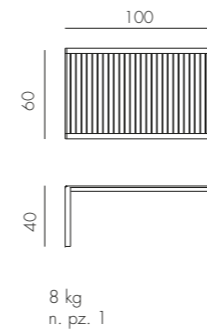

## ARIA TAVOLINO 60

polipropilene

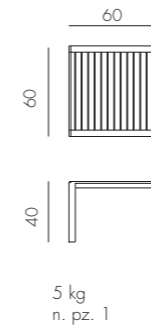

## POP

polipropilene fiberglass

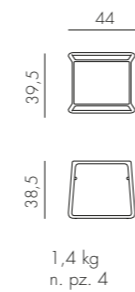







## polipropilene

Polipropilene trattato anti-UV e colorato in massa. Riciclabile al 100%.  
 Polypropylene with UV additives and is uniformly colored. 100% Recyclable resin.  
 Polypropylène traité anti-UV et coloré dans la masse. Résine recyclable 100%.  
 UV-beständigem Polypropylen, voll durchgefärbt. 100% Recyclebarer Kunststoff.  
 Polipropileno tratado anti UV y teñido en masa. Resina reciclable 100%.  
 Polipropileno com tratamento anti-UV colorido na totalidade. Resina reciclável 100%.  
 Полипропилен с обработкой анти-УФ, окрашенное в массе. На 100% пригодно для вторичной переработки.

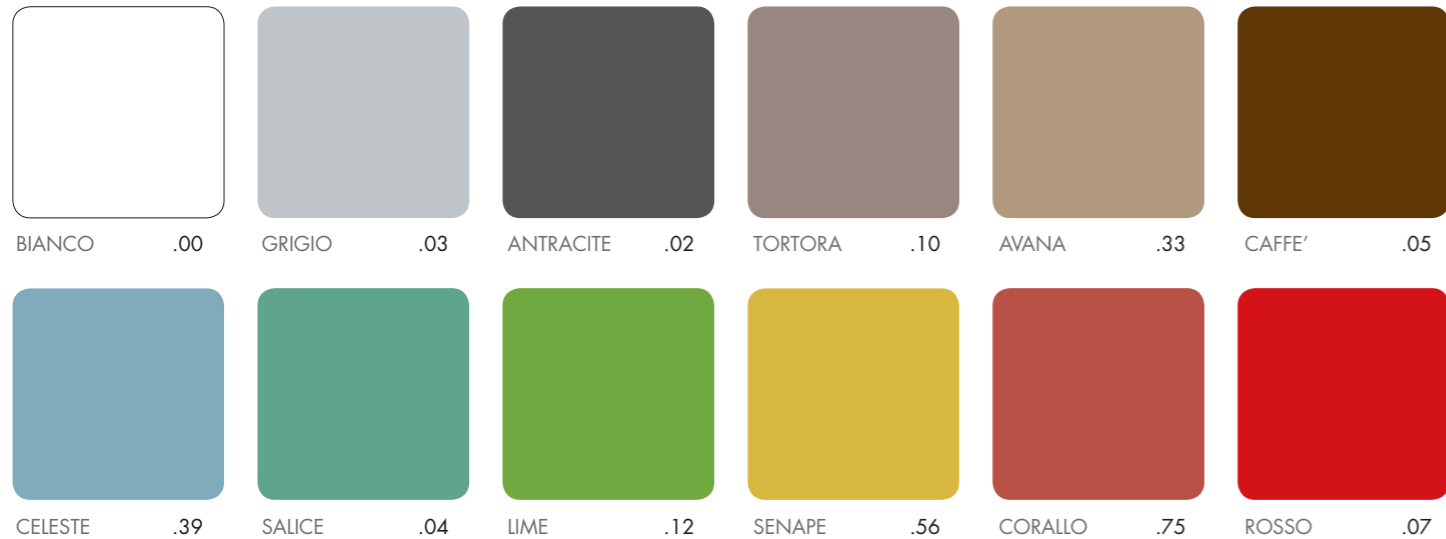

## polipropilene fiberglass

Polipropilene fiberglass trattato anti-UV e colorato in massa. Resina riciclabile al 100%.  
 Uniformly colored fiberglass polypropylene resins with uv additives. 100% Recyclable resin.  
 Polypropylène fiberglass traité anti-uv et coloré dans la masse. Résine recyclable 100%.  
 UV-beständigem fiberglass Polypropylen, voll durchgefärbt. 100% Recyclebarer Kunststoff.  
 Polipropileno fiberglass tratado anti UV y teñido en masa. Resina reciclable 100%.  
 Polipropileno fiberglass com tratamento anti-UV colorido na totalidade. Resina reciclável 100%.  
 Полипропилен фиброволокно с обработкой анти-УФ, окрашенное в массе. На 100% пригодно для вторичной переработки.

## tessuto acrilico



Fibra Acrilica 100% tinta in massa. Solidità alla luce 7/8. Sfoderabile/zip, lavabile a 30°.  
 Trattamento antimacchia, antimuffa.  
 100% acrylic fiber mass dyed. Light fastness 7/8. Removeable/zip, washable at 30°.  
 Stain-proof, mould-proof.  
 100% fibre acrylique teintée en masse. Solidité à la lumière 7/8. Déhoussable/zip, lavable à 30°.  
 Traitement anti-taches, anti-moisissure.  
 100% fasergefärbtes Acryl. Lichtbeständigkeit 7/8. Abziehbarer/zip, waschbar bei 30°.

Mit Anti-Flecken- und Anti-Schimmel-Behandlung.  
 100% fibra acrílica tintada en masa. Solidez a la luz 7/8. Desenfundable/zip, lavable a 30°.  
 Tratamiento antimanchas, antimoho.  
 100% fibra acrílica tingida em massa. Resistência à luz 7/8. Removível/zip, lavável a 30°.  
 Tratamento antimancha, antimoho.  
 100% акриловое волокно, окрашенное в процессе производства. Светостойкость 7/8.  
 Съемная ткань/на молнии, стирка при 30°. Обработка против пятен, противогрибковая.



## durelTOP



DurelTOP è un sistema innovativo di produzione di piani per tavoli studiati per raggiungere i più elevati livelli di praticità, resistenza, robustezza ed eleganza. I piani DurelTOP sono ad alto spessore, formati da un doppio strato tamburato perfettamente chiuso. Prodotti in polipropilene di prima qualità, sono inalterabili all'acqua, resistenti al sole e facili da pulire. DurelTOP è il risultato di una lunga ricerca tecnologica e dell'esperienza decennale nella lavorazione delle materie plastiche della NARDI, da sempre all'avanguardia nell'ambiente contract e giardino.

The DurelTOP is an innovative new system in the production of tabletops developed to reach the highest levels of practicality, resistance, and elegance. The DurelTOP tabletops have a greater thickness, formed by a double layer enclosure perfectly closed. Produced in first quality polypropylene, they are resistant to water, resistant to sunlight, and are easy to clean. DurelTOP is a result of a decade's long research and development in plastics by Nardi, always a leader in the contract and garden sectors.

DurelTOP est un système innovateur de production de plateaux de tables, il est étudié pour retrouver le meilleur niveau de pratique de résistance et d'élégance. Les plateaux DurelTOP sont très épais, formés de doubles couches parfaitement finies. Ce sont des produits en polypropylène de première qualité, ils sont inaltérables à l'eau, résistants au soleil et faciles à nettoyer. DurelTOP est le résultat d'une longue recherche technologique et une expérience décennale dans le travail des matières plastique de la Sté NARDI, toujours à l'avant-garde dans le secteur du contract et jardin.

DurelTOP ist ein neu entwickeltes System für die Produktion von Tischplatten, um ein Höchstmaß an Funktionalität, Widerstandsfähigkeit und Eleganz zu erreichen. Durch das innen verstärkte "Zwei-Schichten-Hohlraum-System" erreicht die DurelTOP Tischplatte einen stärkeren Querschnitt und damit ein Höchstmaß an Festigkeit. Hergestellt aus hochwertigem Qualitätspolypropylen

ist sie resistent gegen Wasser und Sonnenlicht und dabei leicht zu reinigen. DurelTOP ist das Ergebnis von 10 Jahren Forschung und Entwicklung auf dem Kunststoffsektor durch Nardi, immer der führende im Bereich Contract- und Gartenmöbel.

DurelTOP es un nuevo sistema de fabricación de tableros de mesa estudiado para alcanzar los mas altos niveles de practicidad, resistencia, robustez y elegancia. Los tableros DurelTOP de gran solidez, estan formados por una doble capa perfectamente unida y sellada. Fabricados en polipropileno de primera calidad son inalterables al agua, resistentes al sol y de fácil limpieza. DurelTOP es el resultado de una prolongada investigación tecnológica y de la experiencia acumulada en los mas de diez años que Nardi lleva produciendo materias plasticas, siempre innovando en ambientes contract y jardin.

DurelTOP é um sistema de inovação da produção de tampos de mesa concebidos para atingir a máxima resistência, práticos e elegantes. Os tampos de mesa DurelTOP são formados por uma camada dupla e perfeitamente unida. Produzidos em polipropileno de primeira qualidade, são resistentes ao sol e fáceis de limpar. DurelTOP é o resultado de uma longa investigação tecnológica em materiais plásticos da Nardi, leader em mobiliário de jardim.

DurelTOP — это инновационная система производства столешниц, позволяющая изготавливать практичные, прочные, крепкие и элегантные столешницы. Столешницы DurelTOP обладают высокой плотностью и состоят из двойной панели с мелкопустотным заполнением, полностью закрытой. Изделия из полипропилен высокого качества устойчивы к воде, солнцу и просты в уходе. DurelTOP — это результат многолетних технологических исследований и десятилетнего опыта NARDI в обработке пластмасс, лидера в производстве садовой мебели и контрактном секторе.

## tessuto acrilico stampato



Fibra Acrilica 100% stampa digitale. Solidità alla luce 6. Sfoderabile/zip, lavabile a 30°.  
 100% acrylic fibre with digital print. Light fastness 6. Removeable/zip, wash at 30°.  
 100% fibre acrylique impression numérique. Solidité lumière 6. Déhoussable/zip, lavable à 30°.  
 100 % Acrylfaser mit Digitaldruck. Lichtechtheit 6. Abziehbar/mit Reißverschluss, waschbar bei 30°.

100% fibra acrílica impresión digital. Solidez a la luz 6. Desenfundable/cremallera, lavable a 30°.  
 100% fibra acrílica estampa digital. Resistência à luz 6. Removível/zíper, lavável a 30°.  
 100% акриловое волокно с цифровым рисунком, окрашенное в процессе производства. Светостойкость 6. Съемная ткань/на молнии, стирка при 30°.

## CUSCINO PASSPARTOUT



tropical .081  
190 gr/m<sup>2</sup>



## tessuto Sunbrella® NATTE'



100% fibra acrilica SUNBRELLA® tinta in massa, con trattamento CLEANGARD® idrorepellente e anti-macchia. Solidità alla luce 8/8. Sfoderabile con ZIP, lavabile a 40°.

100% acrylic SUNBRELLA® fibre, batch dyed, with CLEANGARD® water-repellent and stain-resistant treatment. 8/8 light fastness. Removable cover with ZIP fastening, washable at 40°.

100 % fibre acrylique SUNBRELLA® teintée dans la masse, avec traitement CLEANGARD® imperméable et anti-tache. Résistance à la lumière 8/8. Déhoussable avec fermeture éclair, lavable à 40°.

100 % durchgefärbte Acrylfaser SUNBRELLA®, mit wasser- und schmutzabweisender CLE-

ANGARD®-Ausrüstung. Lichtechtheit: 8/8. Abziehbar mit Reißverschluss, waschbar bei 40°.

100% fibra acrilica SUNBRELLA® teñida en masa, con tratamiento CLEANGARD® hidrorrepelente y antimancha. Solidez a la luz 8/8. Desenfundable con cremallera, lavable a 40°.

100% fibra acrilica SUNBRELLA® tingida em massa, com tratamento CLEANGARD® hidrorrepelente e antimancha. Solidez à luz 8/8. Forro removível com ZIPER, lavável a 40°.

100% акриловое волокно SUNBRELLA® окрашенное при изготовлении, с водоталкивающей обработкой против пятен CLEANGARD®. Устойчивость к свету 8/8.

Съемный на молнии, стирка при 40°.

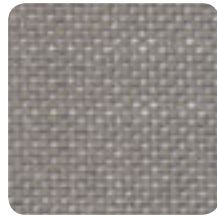

grigio Sunbrella® .136  
280 gr/m²

## imbottitura / padding

### CUSCINO NET BENCH - NET RELAX - NET - SEDUTA ARIA - FIT ARIA

Poliuretano espanso. Polyurethane foam. Mousse polyuréthane. Polyurethanschaum. Espuma de poliuretano. Espuma de poliuretano. Пенополиуретан.

### CUSCINO SHELL

Poliuretano espanso su struttura rigida di polipropilene. Polyurethane foam over solid polypropylene frame. Polyuréthane expansé sur structure rigide de polypropylène. Polyurethanschaumstoff auf starrem Polypropylengestell. Poliuretano expandido sobre estructura rígida de polipropileno. Poliuretano expandido sobre estrutura rígida de polipropileno. Пенополиуретан на жесткой конструкции из полипропилена.

### CUSCINO ARREDO ARIA

Poliuretano espanso rivestito da fibra poliestere. Polyurethane foam with polyester fiber. Mousse polyuréthane avec fibres de polyester. Polyurethanschaum beschichtet Polyesterfasern. Espuma de poliuretano cubierta con fibras de poliéster. Espuma de poliuretano com cobertura fibras de poliéster. Пенополиуретан обшивка из полиэстера.

### CUSCINO PASSPARTOUT

Fibra di poliestere. Polyester fiber. Fibres de polyester. Polyesterfasern. Fibras de poliéster. Fibras de poliéster. Обшивка из полиэстера.

## tessuto sintetico

Tessuto in filo di poliestere rivestito in pvc. Fabric is made of a polyester fiber, with a pvc coating. Tissu en fil de polyester revêtu de pvc. Gewebe aus PVC-ummantelten

Polyesterfasern. Tejido en hilo de poliéster recubierto de pvc. Tecido de fibra polyester com cobertura pvc. Ткань из полиэфирных нитей с покрытием из ПВХ.

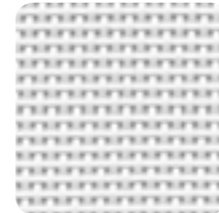

bianco .107  
tela 1x1

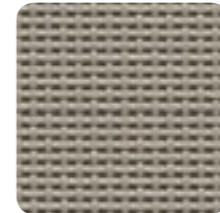

tortora .104  
tela 1x1

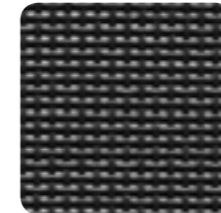

antracite .057  
tela 1x1

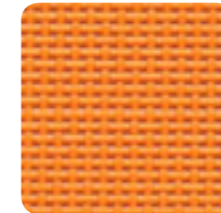

mandarino .083  
tela 1x1

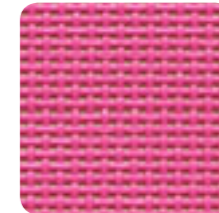

rosa .056  
tela 1x1

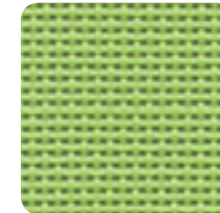

prato .084  
tela 1x1



celeste .075  
tela 1x1

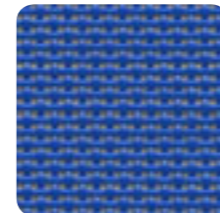

blu .102  
tela 1x1

## alluminio

### anodizzato

L'anodizzazione è un processo elettrolitico che aumenta l'ossidazione delle superfici prevenendo la corrosione con uno strato protettivo.

Anodizing is an electrolytic procedure that increases oxidation of the surfaces, preventing corrosion with a protective layer.

L'anodisation est un procédé électrolytique qui augmente l'oxydation des surfaces empêchant ainsi la corrosion grâce à une couche de protection.

Die Eloxierung ist ein elektrolytischer Prozess, der die Oxydierung der Obefflächen erhöht und der Korrosion mit einer Schutzschicht vorbeugt.

La anodización es un proceso electrolítico que aumenta el poder de oxidación de las superficies evitando de esta manera la corrosión mediante una capa protectora.

A anodização é um processo electrolítico que aumenta a oxidação das superfícies prevenindo a corrosão com uma camada protectora.

Анодирование представляет собой электролитный процесс, который повышает окисление поверхностей, предотвращая коррозию благодаря образованию защитного слоя.

### verniciato

La verniciatura è a polvere di poliestere. The painting is with polyester powder. La peinture est à poudre de polyester. Die Epoxierung erfolgt mit Polyesterpulver. El pintado se realiza

con polvo de poliéster. O pó de poliéster é usado para envernizar. Окраска производится при помощи порошкового полиэстера.



verniciato bianco .53



verniciato tortora .59



verniciato caffè' .57



verniciato antracite .52



## vetro

Vetro float temperato serigrafato e vetrificato a 700°C.  
Tempered Float glass, screen-printed and vitrified at 700° C.  
Verre float trempé sérigraphié et vitrifié à 700°C.  
Sicherheitsglas mit innenliegendem Dekorsiebdruck,

verglasst bei 700°.  
Vidrio float, templado, serigrafiado y vetrificado a 700°C.  
Vidro float temperado, impresso e vitrificado a 700°C.  
Сериграфированное закаленное стекло float, производимое при 700°C.



BIANCO

.00



ANTRACITE

.02

## laminato HPL

Laminato decorativo ad alta pressione, compatto, omogeneo, non poroso, ad alta densità.  
Decorative high pressure laminate, solid, homogeneous, non-porous and with a high density.  
Stratifié décoratif à haute pression, condensé, homogène, pas poreux, haute densité.  
HPL-Laminat, beständig, homogen, hoch verdichtet.

Laminado decorado a alta presión, compacto, homogéneo, no poroso y de alta densidad.  
Decorativo e laminado a alta pressão, sólido, homogéneo, não poroso e de grande densidade.  
Декоративный ламинат высокого давления, компактный, однородный, непористый, с высокой плотностью.



BIANCO

.301



ANTRACITE

.303



impilabile stackable empilable stapelbar apilable empilhável стекируемые



impilabile orizzontalmente stackable horizontally piètement encastrable horizontal stapelbar apilable horizontalmente empilhável horizontalmente горизонтальная расстановка



pieghevole folding pliant klappbar plegable dobrável складывающийся



reclinabile reclining dossier réglable verstellbare Rückenlehne reclinable reclinável откидной

Tutte le sedute sono dotate di piedini antiscivolo. All chairs are equipped with non-slip rubber feet. Tous les sièges sont équipés avec embouts anti-dérapants. Alle Stühle sind mit rutschfesten Fußkappen ausgestattet. Todos los asientos están equipados con tacos antideslizantes. Todos os assentos estão equipados com pés anti-derrapantes. Ножки всех стульев оснащены противоскользящей резиновой подложкой.

Sui colori scuri, ombre ed altri difetti minori sono più evidenti rispetto ai colori chiari e sono da ritenersi standard. On dark colors, shadows and other minor faults are more evident than on lighter colors and are therefore standard. Sur les couleurs sombres, les ombres et les autres petits défauts sont plus marqués que sur les couleurs claires et sont tout à fait standards. Auf dunklen Farben sind Schatten und andere kleinere Mängel sichtbarer als auf hellen Farben und sind daher als Standard zu betrachten. Las sombras y demás defectos menores son más evidentes sobre los colores oscuros respecto a los colores claros y tienen que considerarse como estándares. Em cores escuras, sombras e outros defeitos menores são mais evidentes do que em cores claras e devem ser considerados standard. По сравнению со светлыми цветами на темных цветах тени и другие небольшие дефекты более заметны и должны считаться нормой.

Il peso (kg), le misure (cm) e i colori riportati sono indicativi. La NARDI si riserva il diritto di apportare modifiche o varianti senza preavviso. Tutti i modelli sono depositati. Weights (kg), dimensions (cm) and colors are indicative only. NARDI reserves the right to make changes or variations without notice. All models are patented. Le poids (kg), les dimensions (cm) et les coloris indiqués sont fournis purement à titre indicatif. La Firme NARDI se réserve le droit d'apporter toute modification ou variation sans aucun préavis. Tous les modèles sont déposés. Alle Farb-, Maß- (cm) und Gewichtsangaben (kg) sind nicht als fest bindend anzusehen. Firma NARDI behält sich das Recht von Änderungen. Alle Modelle sind gesetzlich geschützt. El peso (kg), las medidas (cm) y los colores detallados, son indicativos. La firma NARDI se reserva el derecho de modificaciones o variaciones sin previo aviso. Todos los modelos llevan nuestra marca. O peso (kg), as medidas (cm) e as cores indicadas, são indicativos. A NARDI reservase o direito de aportar modificações ou variações sem préaviso. Todos os modelos estão depositados. Приведенный вес (кг), размеры (см) и цвета являются ориентировочными. Компания NARDI оставляет за собой права вносить изменения и вариации без предварительного предупреждения. Все модели зарегистрированы.



STYLING  
Elisa Musso

PHOTO  
studio Raffaello Galiotto

THANKS TO

AYTM  
Bitossi Home  
Ichendorf  
Incipit Lab  
L'Abitare  
Normann Copenhagen