

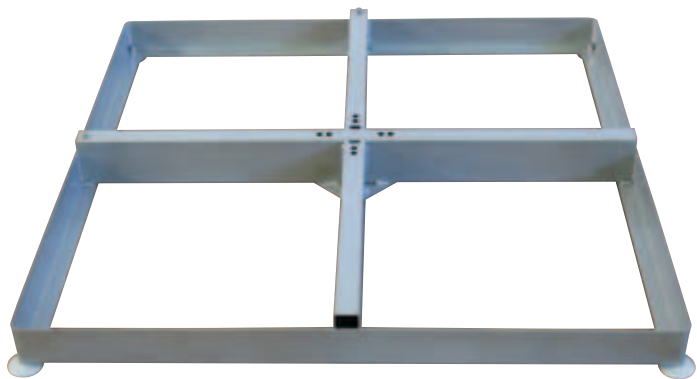

BASI



COD. GBASE003700

GRUPPO BASE P ALU 4 80x80

Powder coated aluminium base. Requires concrete pavers 40x40 cm. Optional wheels.



COD. GRUOT000100

GRUPPO KIT RUOTE D50 X BASE P ALU 4 80X80

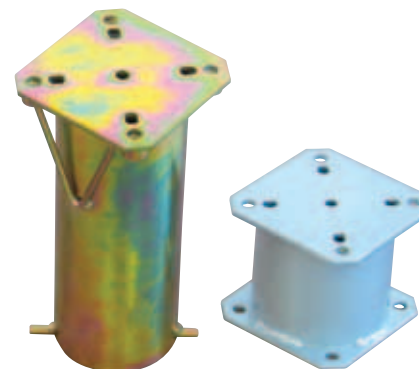

COD. GBASE000900

GRUPPO BASE STYLO UNIV + PR

Galvanized steel base to be set into concrete.

COLOURS



Solution dyed Acrylic fabric

Designed for outdoor use, the solution (spun) dyed acrylic fabric resists salt water, chlorine and any type of harsh climate. Colours do not bleed and remain vibrant for a long time. A specific treatment makes the fabric water repellent, mould resistant and protects it from staining. This type of fabric resists the most extreme conditions and is suitable for year-round use in gardens, terraces, pool sides or on-board boats. It's definitely the top choice canopy fabric to select for your Product.
UPF 50+ (UV Protection Factor) 280 gr/m².

Micro-Mesh fabric

This fabric allows natural air flow and has an excellent resistance to wind, ensuring a pleasant shading at the same time. Suggested to those who want a surely eye-catching alternative fabric. Its fibre composition, taking advantage of the "Preconstraint" technology, guarantees an exceptional resistance to tearing, ultraviolet light and mould.
410 gr/m².

Airfim fabric

Waterproof fabric assuring total protection from rain, which does not even permeate the stitches. A stain-resistant treatment contributes toward a better dirt resistance of the fabric, too. A regular wash with a neutral cleaning agent guarantees a long lifespan.
UPF 80 (UV Protection Factor) 190 gr/m².



Solution dyed Acrylic Fabric



S00 Natural
5404



S01 Canvas
5453

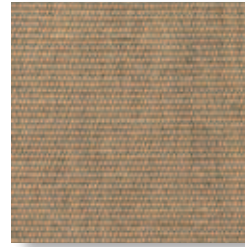

S03 Heather Beige
5476

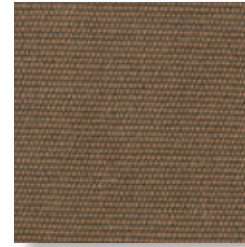

S15 Cocoa
5425

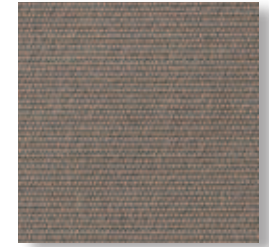

S04 Taupe
3729



S10 Walnut
5470



S16 Shingles
3706

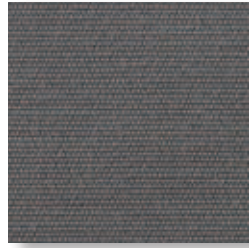

S18 Gray
3737

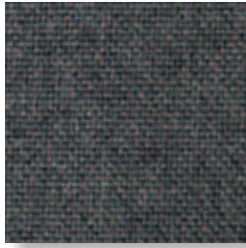

N01 Sooty
10030

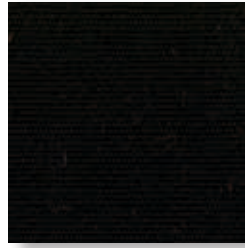

S13 Black
5408



S21 Sunflower
5457

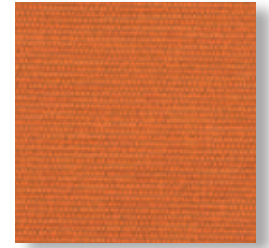

S11 Tuscany
5417



S14 Logo Red
5477



S19 Clay Court
3744



S06 Macao
3738



S07 Forest Green
5446

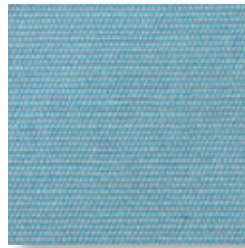

S05 Mineral Blue
5420



S09 Navy Blue
5439



S24 Narval
3763



S28 Parma
3761

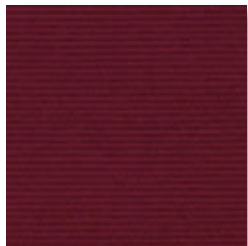

S29 Burgundy
5436



M03 Bianco
5001

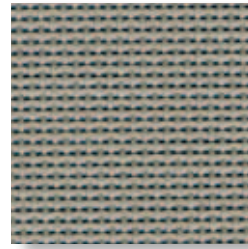

M01 Cenere
5014

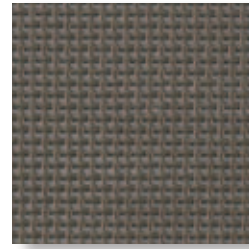

M02 Coffee
5015

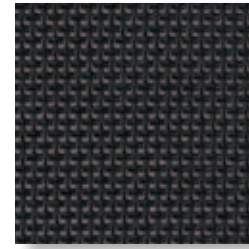

M00 Nero
5005

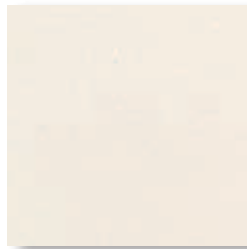

I05 Bianco
9755



I01 Ecrù
9883



I02 Verde
9710



I03 Blue
9545



I00 Bordeaux
9879



I07 Gray
9654

The colors may differ from the real ones.

FINISHES

Frame finishes



SILV





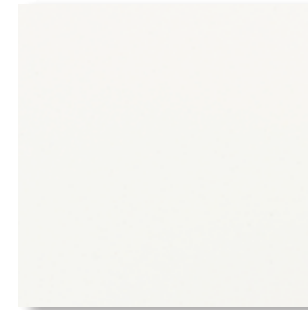

GRAF



BIAN

*The materials used have been specifically selected and treated to maintain our products durability and consistency over time.
The colors may differ from the real ones.*

TECHNICAL FEATURES

PRODUCT	SIZE (cm))		TECHNICAL FEATURES				
	400x400	Ø 560	STRUCTURE				
MAXI SILVER	•	•	Aluminium silver	•	•	•	200 kg
COD.	MAX#400400AS00	MAX#000560AS00					
MAXI GRAFITE	•	•	Aluminium graphite	•	•	•	200 kg
COD.	MAX#400400AG00	MAX#000560AG00					
MAXI BIANCO	•	•	Aluminium white	•	•	•	200 kg
COD.	MAX#400400AB00	MAX#000560AB00					

SIMBOLS TABLE

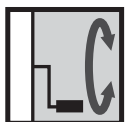

Winch opening.



Ribs can be changed without dismantling the frame.



Telescopic system.



Minimum required base weight.

MAXI 400x400

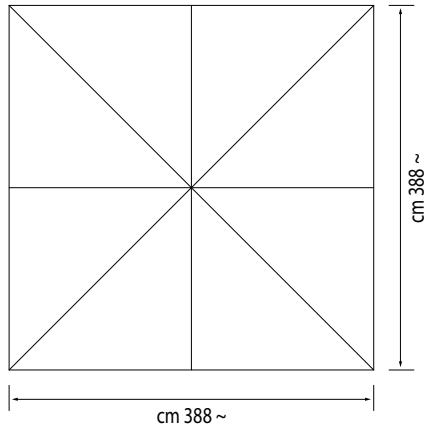

MAXI D 560

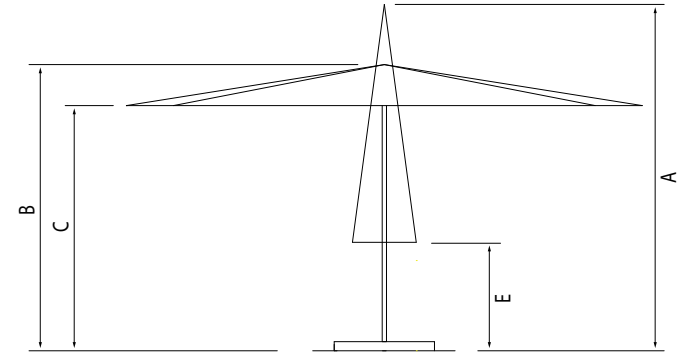
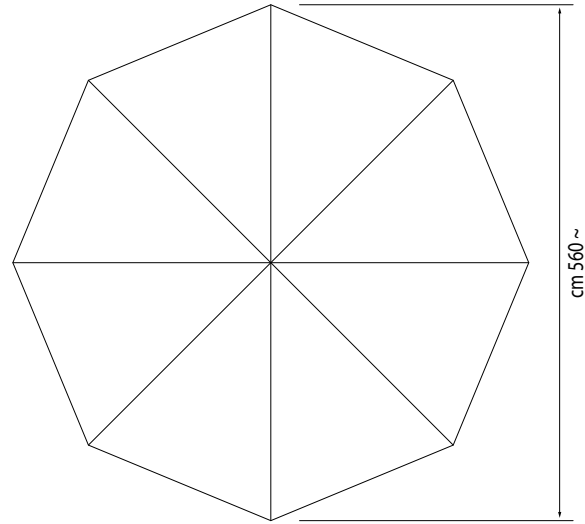

MAXI MEASURE TABLE

SIZE (cm)	A	B	C	E
400x400	385	325	265	102
D 560	385	325	265	102

GBASE003700

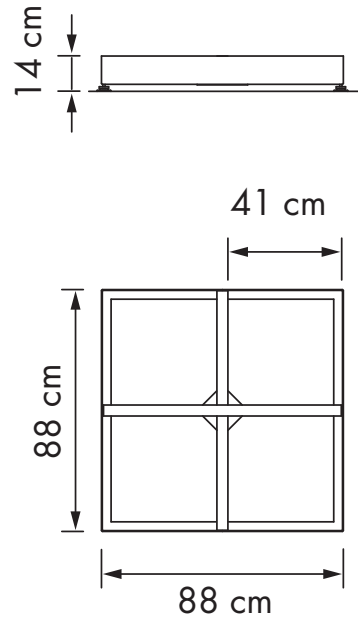

GBASE000900

