

# ITALIAN DESIGN





WELCOME



NEL 1949 IN UNA PICCOLA BOTTEGA  
ITALIANA VENIVA CREATO IL PRIMO  
LETTINO DA MARE...

DA ALLORA L'AZIENDA MIGANI È CRESCIUTA FINO A  
DIVENTARE UNA MODERNA INDUSTRIA.  
NEL FARSÌ GRANDE HA SAPUTO MANTENERE  
QUELLO SPIRITO ARTIGIANO CHE È ESPRESSIONE DEL GUSTO  
PER LE COSE BEN FATTE.

IN 1949 IN A SMALL ITALIAN  
SHOP BORNED THE FIRST  
"BEACH-SUNBED" ...

SINCE THEN THE MIGANI HAS BECOME GREAT BY HOLDING  
TENACIOUSLY TO THAT SPIRIT OF CRAFTSMANSHIP WHICH MAR-  
KED ITS BEGINNINGS AND WHICH IS THE OUTWARD SIGN OF  
A LOVE FOR WHEEL-MADE PRODUCTS. SPECIALISATIONS IN THE  
SECTOR, TECHNICAL EXPERIENCE AND ATTENTION TO DESIGN  
HAVE MADE IT POSSIBLE TO CREATE COLLECTIONS OF ELEGANT  
COMFORTABLE OUTDOOR FURNITURE MADE TO LAST.



## COLLEZIONE ALLUMINIO ALUMINIUM COLLECTION

I NOSTRI ARTICOLI SONO COSTRUITI ESCLUSIVAMENTE CON L'IMPIEGO DI TUBOLARI DI **ALLUMINIO PRIMARIO**, PROVENIENTI DAI MAGGIORI ESTRUSORI MONDIALI. LE SEZIONI DEI PROFILATI IMPIEGATI SONO TALI DA ASSICURARE AI NOSTRI PRODOTTI UNA **ELEVATISSIMA RESISTENZA**.

LE SALDATURE EFFETTUATE CON INNOVATIVI IMPIANTI AUTOMATIZZATI VENGONO SUCCESSIVAMENTE CONTROLLATE E VERIFICATE UNA A UNA AL FINE DI ASSICURARE E GARANTIRE LA **QUALITÀ TOTALE DEL PRODOTTO**. NELL'ASSEMBLAGGIO DEI VARI COMPONENTI, ESEGUITI IN SERIE, MA CON LA **CURA E L'ATTENZIONE PROPRIA DELL'ARTIGIANO**, VENGONO UTILIZZATI ESCLUSIVAMENTE FERRAMENTA INOX E ACCESSORI IN NYLON DELLE MIGLIORI QUALITÀ.

OUR PRODUCTS ARE MADE EXCLUSIVELY FROM **TOP-QUALITY ALUMINIUM** TUBING FROM THE FOREMOST EXTRUDERS IN THE WORLD.

SECTION CUTTING IS GUARANTEED TO MAKE OUR PRODUCTS **HIGHLY RESISTANT**. WELDING IS CARRIED OUT BY MEANS OF INNOVATIVE AUTOMATED EQUIPMENT, AND IS THEN CHECKED AND DOUBLE-CHECKED TO ENSURE AND GUARANTEE THE **OVERALL QUALITY OF THE FINISHED PRODUCT**. ASSEMBLY OF THE COMPONENT PIECES IS CARRIED OUT IN SERIES, BUT WITH ALL THE CARE AND **ATTENTION OF THE CRAFT WORKER**, USING ONLY TOP-QUALITY STAINLESS STEEL FITTINGS AND NYLON ACCESSORIES.



## COLLEZIONE LEGNO WOOD COLLECTION

I NOSTRI ARTICOLI SONO REALIZZATI ESCLUSIVAMENTE CON **LEGNO DI FRASSINO DI PRIMA QUALITÀ**, PROVENIENTE DALLE MIGLIORI SEGHERIE EUROPEE, SELEZIONATO ED ACCURATAMENTE LAVORATO IN SPESSORI TALI DA GARANTIRE AL PRODOTTO LA **MASSIMA RESISTENZA**.

L'ACCURATO ASSEMBLAGGIO DEI MATERIALI CON COLLA MARINA E L'UTILIZZO ESCLUSIVO DI FERRAMENTA IN ACCIAIO INOX, CONSENTONO A TUTTI I NOSTRI ARTICOLI DI ESSERE UTILIZZATI SIA ALL'INTERNO CHE ALL'ESTERNO.

OUR PRODUCTS ARE MADE EXCLUSIVELY OF **TOP-QUALITY ASH-WOOD** FROM THE FOREMOST SAWMILLS IN EUROPE, CAREFULLY SELECTED AND PROCESSED IN THICKNESSES DESIGNED TO ENSURE **MAXIMUM STRENGTH**.

CAREFUL ASSEMBLY OF THE MATERIALS, USING SPECIAL GLUE AND STAINLESS STEEL FITTINGS, ENSURE THAT OUR PRODUCTS CAN BE USED BOTH INDOORS AND OUT.

06

LETTINI LEGNO  
WOOD SUNBED



09

SDRAIO LEGNO  
REGISTA LEGNO  
WOOD DECKCHAIRS  
DIRECTOR'S CHAIR



12

TAVOLI LEGNO  
E ALLUMINIO  
WOOD AND  
ALUMINIUM TABLE



20

COLLEZIONE OUTDOOR  
ESAEDRO - HAPPY  
ESAEDRO - HAPPY  
OUTDOOR COLLECTION



26

LETTINI  
ALLUMINIO  
ALUMINIUM SUNBED



40

SDRAIO  
ALLUMINIO  
ALUMINIUM DECKCHAIRS



48

OMBRELLONI  
BEACH UMBRELLAS



65

CABINE  
BATHING HUTS



66

GAZEBO  
GAZEBO



68

ACCESSORI SPIAGGIA  
BEACH ACCESSORIES

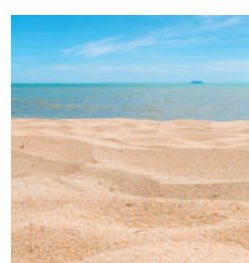

70

FOTOVOLTAICO  
PHOTOVOLTAIC



75

TESSUTI  
FABRICS



# LETTINO IN LEGNO RELAX RELAX WOODEN SUNBED

STRUTTURA REALIZZATA INTERAMENTE IN LEGNO DI FRASSINO DI PRIMA QUALITÀ. REGOLAZIONE DELLO SCHIENALE A 5 INCLINAZIONI.

STRUCTURE MADE ENTIRELY OF FIRST QUALITY ASH WOOD. 5 DIFFERENT ANGLES OF THE BACK.

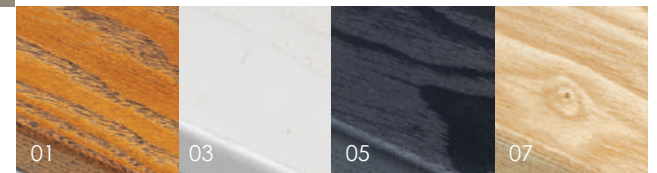

FINITURE DISPONIBILI:  
FINISHES AVAILABLE:

01 NOCE WALNUT  
03 SBIANCATO BLEACHED  
05 NERO BLACK  
07 NATURALE NATURAL

OPTIONAL

MATERASSINO ERGONOMICO DISPONIBILE  
IN VARI COLORI E SPESSORI

MATRESS AVAILABLE IN VARIOUS COLORS  
AND THICKNESSES

DIMENSIONI:  
DIMENSIONS:

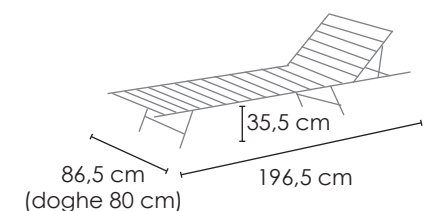
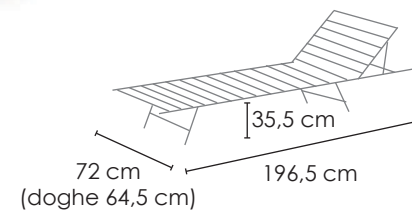



# LETTINO IN LEGNO LUXURY LUXURY WOODEN SUNBED

NEWS

STRUTTURA IN LEGNO DI FRASSINO DI PRIMA QUALITÀ. STRUTTURA INTERNA IN ALLUMINIO VERNICIATO. REGOLAZIONE DELLO SCHIENALE A 5 INCLINAZIONI. POSSIBILITÀ DI PERSONALIZZAZIONE DELLA TELA.

STRUCTURE MADE OF FIRST QUALITY ASH WOOD. INTERNAL STRUCTURE IN PAINTED ALUMINUM. 5 DIFFERENT ANGLES OF THE BACK. POSSIBILITY OF CUSTOMIZING THE FABRIC.

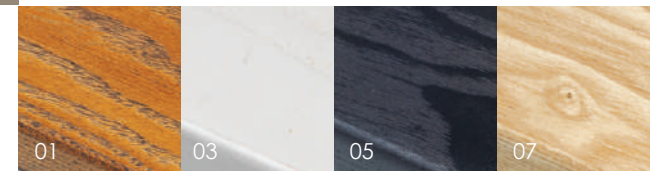

FINITURE DISPONIBILI:  
FINISHES AVAILABLE:

01 NOCE WALNUT  
03 SBIANCATO BLEACHED  
05 NERO BLACK  
07 NATURALE NATURAL

OPTIONAL

MATERASSINO ERGONOMICO DISPONIBILE  
IN VARI COLORI E SPESSORI

MATRESS AVAILABLE IN VARIOUS COLORS  
AND THICKNESSES

DIMENSIONI:  
DIMENSIONS:

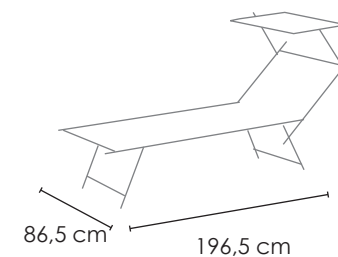

# ≡ LETTINO IN LEGNO WOOD SUNBED

LETTINO IN LEGNO MASSELLO DI FRASSINO.  
3 POSIZIONI MODELLO "EXTRA" CON  
O SENZA TETTUCCIO.

SUNBED WITH 3 INCLINATIONS "EXTRA" MODEL,  
IMPREGNATED WALNUT AVAILABLE WITH  
OR WITHOUT SUNSHIELD

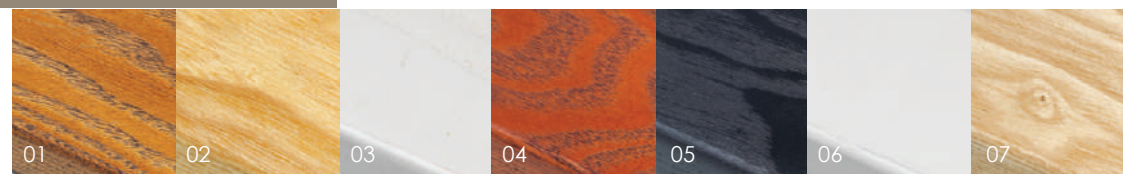

FINITURE DISPONIBILI:  
FINISHES AVAILABLE:

- 01 NOCE WALNUT
- 02 OLIO OIL
- 03 SBIANCATO BLEACHED
- 04 MOGANO MAHOGANY
- 05 NERO BLACK
- 06 BIANCO PIENO FULL WHITE
- 07 NATURALE NATURAL

DIMENSIONI:  
DIMENSIONS:

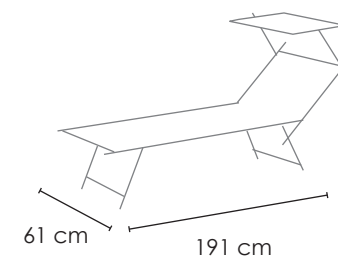



# SDRAIO IN LEGNO WOOD DECKCHAIRS

SDRAIO IN LEGNO  
CON O SENZA BRACCIOLI

DECKCHAIR  
WITH OR WITHOUT ARMREST



3 POSIZIONI  
3 POSITIONS



4 POSIZIONI  
4 POSITIONS

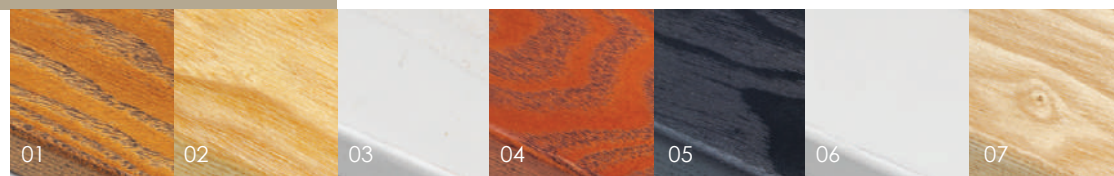

FINITURE DISPONIBILI:  
FINISHES AVAILABLE:

- 01 NOCE WALNUT
- 02 OLIO OIL
- 03 SBIANCATO BLEACHED
- 04 MOGANO MAHOGANY
- 05 NERO BLACK
- 06 BIANCO PIENO FULL WHITE
- 07 NATURALE NATURAL

DIMENSIONI:  
DIMENSIONS:

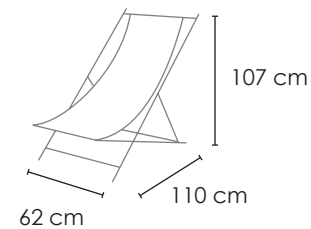

seduta/ seating 30/42 cm

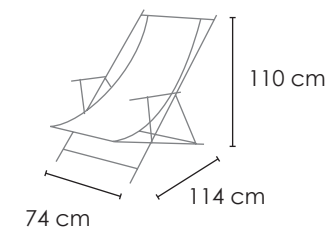

seduta/ seating 35/44 cm

# MARINELLA IN LEGNO WOOD MARINELLA

NEWS



2 POSIZIONI  
2 POSITIONS

POLTRONCINA MARINELLA IN LEGNO.  
MARINELLA ARMCHAIR IN WOOD.

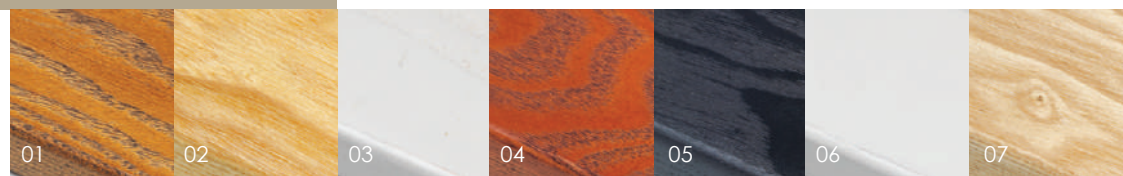

FINITURE DISPONIBILI:  
FINISHES AVAILABLE:

01 NOCE WALNUT  
02 OLIO OIL  
03 SBIANCATO BLEACHED  
04 MOGANO MAHOGANY  
05 NERO BLACK  
06 BIANCO PIENO FULL WHITE  
07 NATURALE NATURAL

DIMENSIONI:  
DIMENSIONS:

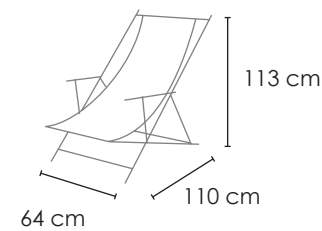

seduta/ seating 35/44 cm

≡ POLTRONCINA REGISTA IN LEGNO  
WOOD REGISTA (DIRECTOR'S CHAIR)

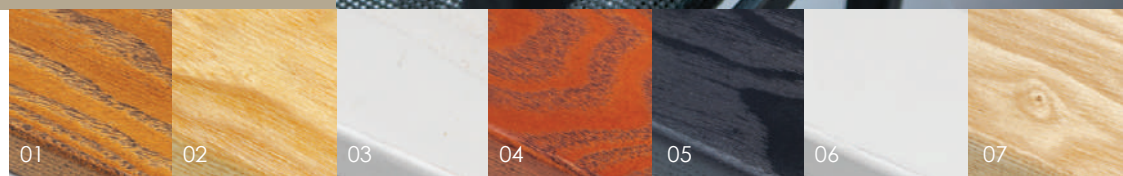

FINITURE DISPONIBILI:  
FINISHES AVAILABLE:

- 01 NOCE WALNUT
- 02 OLIO OIL
- 03 SBIANCATO BLEACHED
- 04 MOGANO MAHOGANY
- 05 NERO BLACK
- 06 BIANCO PIENO FULL WHITE
- 07 NATURALE NATURAL

DIMENSIONI:  
DIMENSIONS:

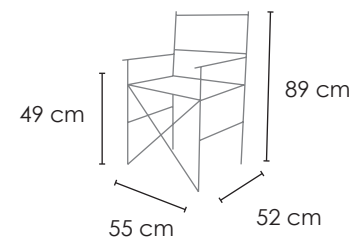



TAVOLINO IN LEGNO  
WOODEN TABLE

H 40 cm  
P 50 cm  
L 50 cm



# TAVOLI TABLES

## TAVOLO ELEGANT IN LEGNO FISSO CON BASAMENTO

FIXED TABLE  
WITH ELEGANT BASE



TAVOLO FISSO H 73 cm  
CON PIANO 80X80 cm  
FINITURA IMPREGNATO NOCE

FIXED TABLE H 73 cm  
WITH WOODEN TOP 80X80 cm  
FINISH WALNUT STAIN



BASAMENTO ELEGANT  
PER PIANI  
70/80/90

ELEGANT BASE  
FOR TOP SIZED  
70/80/90

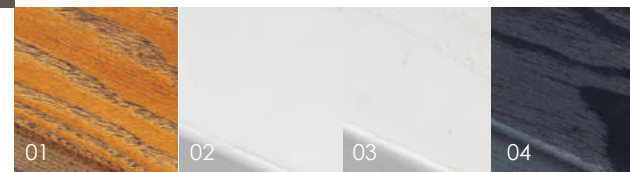

PIANI LEGNO:  
WOODEN TOP:

01 NOCE WALNUT  
02 BIANCO PIENO FULL WHITE  
03 BIANCO DECAPATO BLEACHED  
04 NERO BLACK

DIMENSIONI PIANO:  
DIMENSION TOP:

H 3 cm  
90x90 cm  
80x80 cm  
70x70 cm  
60x60 cm



# TAVOLI TABLES

NEWS

## TAVOLO LIBECCIO LIBECCIO TABLE

TAVOLO CON TELAIO IN ALLUMINIO VERNICIATO E PIANO A DOGHE IN LEGNO DI FRASSINO DI PRIMA QUALITÀ H 75 cm , PIANO 156X80 cm FINITURA IMPREGNATO NOCE.

TABLE WITH PAINTED ALUMINIUM FRAME AND TOP QUALITY ASH SLATTED TOP H 75 cm, TOP 156X80 CM. FINISH WALNUT STAIN.

PIANO LEGNO:  
WOODEN TOP:

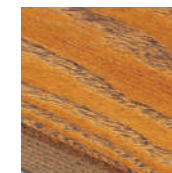

01 NOCE WALNUT

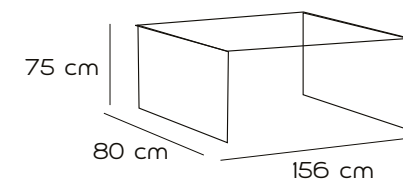

SU RICHIESTA: VIENE FORNITO NELLA VERSIONE SMONTABILE (NON SALDATO)

ON REQUEST: IT IS SUPPLIED IN THE DEMOUNTABLE VERSION (NOT WELDED)



# TAVOLI TABLES

NEWS



SU RICHIESTA: VIENE FORNITO NELLA VERSIONE SMONTABILE (NON SALDATO)

ON REQUEST: IT IS SUPPLIED IN THE DEMOUNTABLE VERSION (NOT WELDED)

## TAVOLO MAESTRALE MAESTRALE TABLE

TAVOLO E PANCA CON TELAIO IN ALLUMINIO VERNICIATO E PIANO A DOGHE IN LEGNO DI FRASSINO DI PRIMA QUALITA'  
H 75 cm , PIANO 186X58 cm  
FINITURA IMPREGNATO NOCE.

TABLE AND BECH WITH PAINTED ALUMINIUM FRAME AND TOP QUALITY ASH SLATTED TOP .  
H 75 cm, TOP 186X58 CM.  
FINISH WALNUT STAIN.

PIANO LEGNO:  
WOODEN TOP:



01 NOCE WALNUT

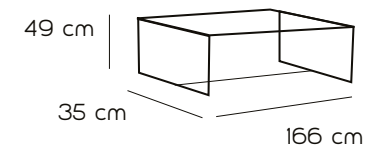
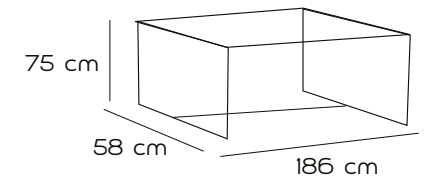

# TAVOLI TABLES

TAVOLO TAVERNA  
CON BASAMENTO FISSO IN ALLUMINIO\*  
E PIANO PERSONALIZZABILE IN LEGNO O STRATIFICATO  
CON LAMINATO

TAVERNA TABLE  
WITH ALUMINIUM\* TABLE BASE AND WOODEN TOP  
OR LAMINATE MOULDED TOP



TAVOLO FISSO H 75 cm

FIXED TABLE H 75 cm

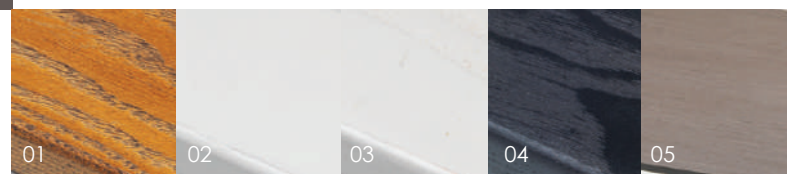

PIANI LEGNO:  
WOODEN TOP:

- 01 NOCE WALNUT
- 02 BIANCO PIENO FULL WHITE
- 03 BIANCO DECAPATO BLEACHED
- 04 NERO BLACK
- 05 STRATIFICATO LAMINATED



DIMENSIONI PIANO:  
DIMENSIONS TOP:

- H 3 cm
- 90x90 cm
- 80x80 cm
- 70x70 cm

\* NO ANODIZZATO  
\* NO ANODIZED





≡ TAVOLI  
TABLES

TAVOLO FISSO ELEGANT  
CON BASAMENTO IN ALLUMINIO

ELEGANT FIXED TABLE  
WITH ALUMINIUM BASE



TAVOLO FISSO H 73 cm  
CON PIANO 80X80 cm

FIXE TABLE H 73 cm  
WITH TOP 80X80 cm

IL TAVOLO VIENE  
FORNITO SMONTATO

TABLE IS SUPPLIED  
UNASSEMBLED

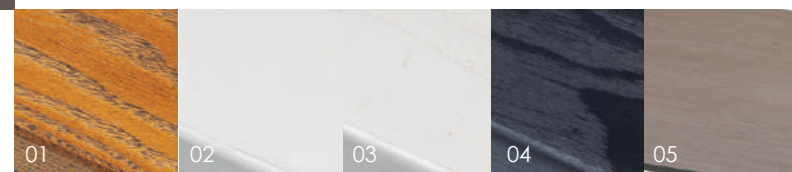

PIANI LEGNO:  
WOODEN TOP:

- 01 NOCE WALNUT
- 02 BIANCO PIENO FULL WHITE
- 03 SBIANCATO BLEACHED
- 04 NERO BLACK
- 05 STRATIFICATO LAMINATED



DIMENSIONI PIANO:  
DIMENSIONS TOP:

- H 3 cm
- 90x90 cm
- 80x80 cm
- 70x70 cm
- 60x60 cm



≡ TAVOLI  
TABLES

TAVOLO ELEGANT ALLUMINIO  
CON BASAMENTO FISSO IN ALLUMINIO ANODIZZATO

ELEGANT ALUMINIUM TABLE  
WITH FIXED ALUMINIUM BASE

TAVOLO ELEGANT FISSO H 73 cm  
PIANO IN ALLUMINIO ANODIZZATO  
ELEGANT FIXED TABLE H 73 cm  
TOP ANODIZED ALUMINIUM



IL TAVOLO VIENE  
FORNITO SMONTATO

TABLE IS SUPPLIED  
UNASSEMBLED



DIMENSIONI PIANO:  
DIMENSIONS TOP:

90x90 cm  
80x80 cm  
70x70 cm

≡ TAVOLI  
TABLES



TAVOLI PIEGHEVOLI ALLUMINIO  
FOLDING TABLES ALUMINIUM

TAVOLO GRANDE/ LARGE TABLE

H 72 cm

P 80 cm

L 80 cm

TAVOLO PICCOLO / SMALL TABLE

H 46 cm

P 42 cm

L 70 cm



TAVOLI FISSI ALLUMINIO  
FIXED ALUMINIUM TABLES

TAVOLO

H 37 cm

P 40 cm

L 60 cm

TAVOLO

H 37 cm

P 40 cm

L 40 cm





LA RAFFINATEZZA DELLA LAVORAZIONE E DEI MATERIALI SONO IL PUNTO DI PARTENZA PER IL PROGETTO DELLA COLLEZIONE, DOVE IL CONTRASTO DEGLI ELEMENTI E L'INFINITA POSSIBILITÀ DI PERSONALIZZAZIONE CONFERISCONO CARATTERE E FASCINO. L'UTILIZZO DEI LEGNI PIÙ PREGIATI CONSENTE DI MANTENERE INALTERATA NEL TEMPO LA SEDUZIONE CHE SI MANIFESTA DAL PRIMO ISTANTE. I TESSUTI UTILIZZATI SONO DISPONIBILI IN DIFFERENTI CROMIE E TRAME DI LAVORAZIONE, CONFEZIONATE CON CURA SARTORIALE.

THE REFINEMENT OF WORKMANSHIP AND MATERIALS ARE THE STARTING POINT FOR THE DESIGN OF THE COLLECTION, WHERE THE CONTRAST OF ELEMENTS AND CUSTOMIZATION LEND CHARACTER AND CHARM. THE USE OF THE MOST VALUABLE TIMBER ALLOWS YOU TO KEEP UNALTERED THE SEDUCTION THAT OCCURS FROM THE FIRST MOMENT. THE FABRICS USED ARE AVAILABLE IN DIFFERENT COLORS AND TEXTURES OF PROCESSING PACKED WITH FINE TAILORING.

# COLLEZIONE OUTDOOR ESAEDRO ESAEDRO OUTDOOR COLLECTION

DIVANETTO E POLTRONCINA:  
STRUTTURA IN ALLUMINIO VERNICIATO O ANODIZZATO,  
SEDUTA IN LEGNO PER ESTERNI.

TAVOLINO:  
STRUTTURA IN ALLUMINIO VERNICIATO O ANODIZZATO,  
PIANO IN LEGNO PER ESTERNI.

SOFA AND SEATING:  
PAINTED OR ANODIZED ALUMINIUM FRAME  
WOODEN SEAT FOR OUTDOOR USE

SMALL TABLE:  
PAINTED OR ANODIZED ALUMINIUM FRAME  
WOODEN TOP FOR OUTDOOR USE

DIMENSIONI:  
DIMENSIONS:

DIVANETTO/ SOFA  
H SEDUTA 43,5 cm  
H TOTALE 71,5 cm  
P 59 cm  
L 129 cm  
PESO 20,9 Kg

POLTRONCINA/ SEATING  
H SEDUTA 43,5 cm  
H TOTALE 71,5 cm  
P 59 cm  
L 70 cm  
PESO 11,6 Kg

TAVOLINO/ SMALL TABLE  
H 42,5 cm  
P 47 cm  
L 75 cm  
PESO 7,5 Kg





# COLLEZIONE OUTDOOR ESAEDRO ESAEDRO OUTDOOR COLLECTION

DIVANETTO E POLTRONCINA:  
STRUTTURA IN ALLUMINIO VERNICIATO O ANODIZZATO,  
SEDUTA IN TELO PVC PERSONALIZZABILE.

TAVOLINO:  
STRUTTURA IN ALLUMINIO VERNICIATO O ANODIZZATO,  
PIANO IN ALLUMINIO

SOFA AND SEATING:  
PAINTED OR ANODIZED ALUMINIUM FRAME  
SEAT IN PVC CLOTH

SMALL TABLE:  
PAINTED OR ANODIZED ALUMINIUM FRAME  
AND TOP



DIMENSIONI:  
DIMENSIONS:

DIVANETTO / SOFA  
H SEDUTA 43,5 cm  
H TOTALE 71,5 cm  
P 59 cm  
L 135 cm  
PESO 20,9 Kg



POLTRONCINA/ SEATING  
H SEDUTA 43,5 cm  
H TOTALE 71,5 cm  
P 59 cm  
L 70 cm  
PESO 11,6 Kg



TAVOLINO/ SMALL TABLE  
H 42,5 cm  
P 51 cm  
L 51 cm  
PESO 6 Kg



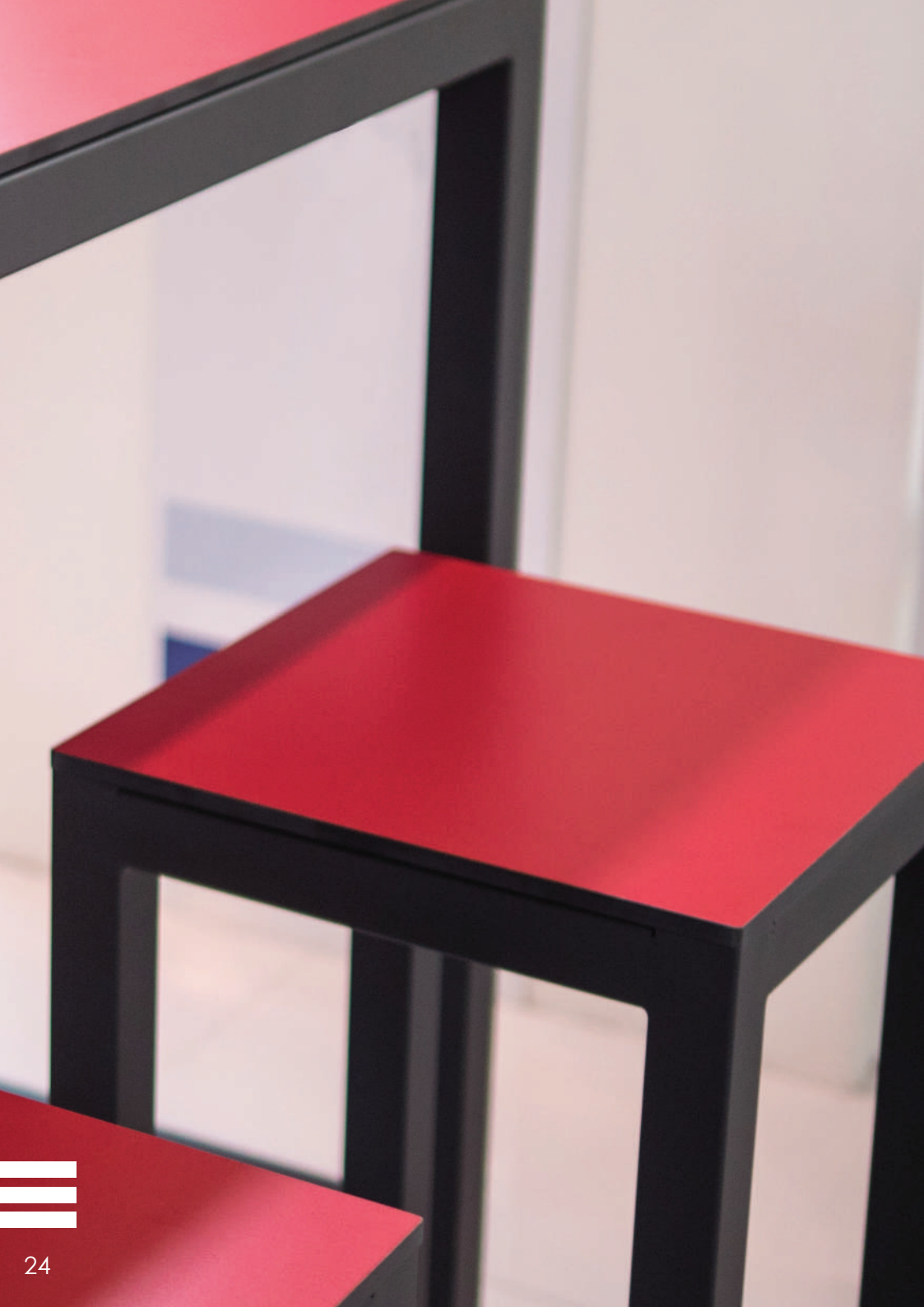



# COLLEZIONE OUTDOOR HAPPY HAPPY OUTDOOR COLLECTION

STRUTTURA IN ALLUMINIO E LAMINATO, SONO APPREZZATI PER LA ROBUSTEZZA E LA DURATA ANCHE IN CONDIZIONI ATMOSFERICHE ESTREME. DISPONIBILE ANCHE IN VERSIONE LEGNO.

MADE OF AN ALUMINUM FRAME AND A LAMINATED SURFACE, THESE PRODUCTS ARE APPRECIATED FOR THEIR FIRMNESS AND RESISTANCE EVEN UNDER EXTREME WEATHER CONDITIONS. ALSO AVAILABLE IN THE WOODEN VERSION.



DIMENSIONI:  
DIMENSIONS:

SGABELLO/ SEATING  
H SEDUTA 80 cm  
P 35 cm  
L 35 cm

TAVOLO/ TABLE  
H 110 cm  
P 60 cm  
L 60 cm

H 110 cm  
P 60 cm  
L 120 cm

H 110 cm  
P 60 cm  
L 180 cm





# LETTINI IN ALLUMINIO ALUMINIUM SUNBEDS

## LE MISURE SIZES

MOD. YOUNG  
MOD. STANDARD  
MOD. SUPERIOR  
MOD. 4 POSIZIONI  
MOD. 5 STELLE

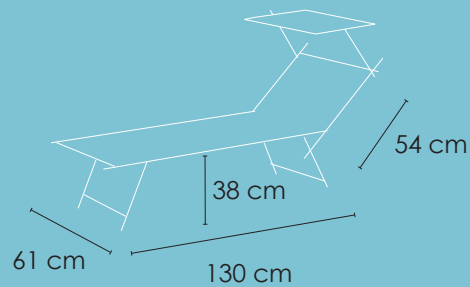

MOD. STANDARD MAXI  
MOD. SUPERIOR MAXI  
MOD. 4 POSIZIONI MAXI  
MOD. 5 STELLE MAXI

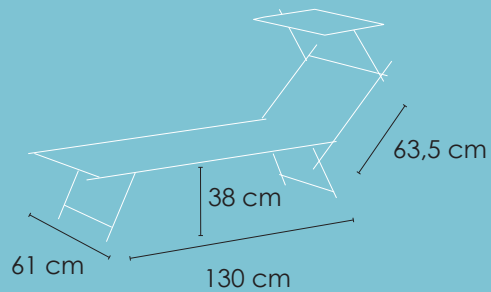

MOD.VIP

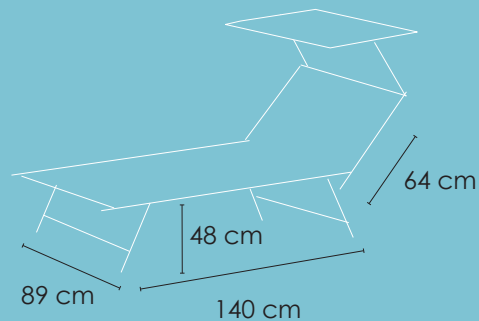

MOD.80

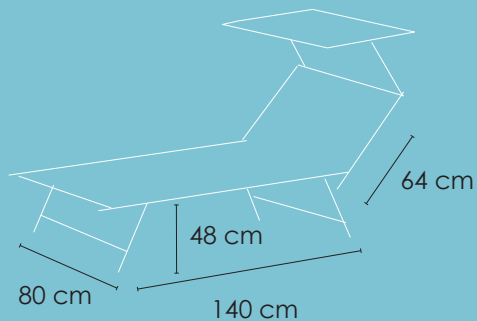

## OPZIONI OPTIONS



FINITURA M\*  
APERTA

FINITURA M\*  
OPEN



FINITURA S\*  
CHIUSA

FINITURA S\*  
CLOSED

\*TUTTI I MODELLI POSSONO ESSERE FORNITI CON IL SISTEMA DI FINITURA TELA M O S AD ESCLUSIONE DEL LETTINO VIP CHE VIENE FORNITO SOLO CON FINITURA S.

\*ALL MODELS CAN BE SUPPLIED WITH FINISHES M OR S ONLY SUNBED VIP CAN BE SUPPLIED IN FINISHES S.



TUTTI I MODELLI POSSONO ESSERE RICHIESTI CON O SENZA TETTUCCIO PARASOLE.

ALL MODELS CAN BE ORDERED WITH OR WITHOUT SUNSHIELD



TUTTI I MODELLI POSSONO ESSERE RICHIESTI CON O SENZA RUOTE

ALL MODELS CAN BE ORDERED WITH OR WITHOUT WHEELS



CUSCINO ERGONOMICO DISPONIBILE IN VARI COLORI. E' APPLICABILE A TUTTI I MODELLI DI LETTINI.

THE ERGONOMIC CUSHION IS AVAILABLE IN DIFFERENT COLOURS, IT CAN BE DEMANDED FOR ALL THE MODELS OF SUNBED.

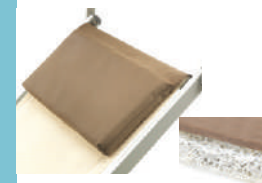

CUSCINO FILTRANTE DISPONIBILE IN VARI COLORI. E' APPLICABILE A TUTTI I MODELLI DI LETTINI.

THE FILTERING CUSHION IS AVAILABLE IN DIFFERENT COLOURS, IT CAN BE DEMANDED FOR ALL THE MODELS OF SUNBED.

# LETTINI IN ALLUMINIO ALUMINIUM SUNBEDS

LETTINO YOUNG  
YOUNG SUNBED



Particolare di ultima generazione studiato dai ns. tecnici per consentire una chiusura delle gambe tenace e morbida allo stesso tempo.

Innovative system for opening and closing of the legs designed for professional use.



MODELLO BASE CON PROFILI STANDARD A TRE INCLINAZIONI, LA TERZA INCLINAZIONE PERMETTE UN ALLINEAMENTO TOTALMENTE ORIZZONTALE DEL LETTINO. PUÒ ESSERE FORNITO CON O SENZA TETTuccio PARASOLE.

SUNBED BASE WITH STANDARD PROFILES MODEL WITH 3 INCLINATIONS OF THE BACKREST, THE THIRD INCLINATION RENDERS THE SUN LOUNGER FULLY HORIZONTAL. ALL MODELS CAN BE ORDERED WITH OR WITHOUT SUNSHIELD.

OPZIONI  
OPTIONS

FINITURA M  
APERTO  
FINITURA M  
OPEN

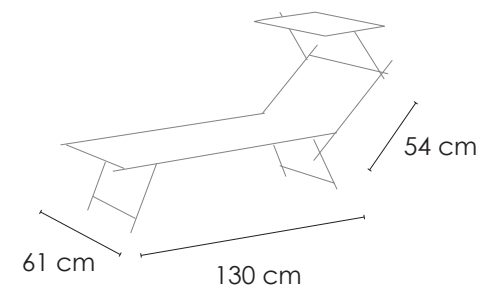

# LETTINI IN ALLUMINIO ALUMINIUM SUNBEDS

## LETTINO STANDARD STANDARD SUNBED



Particolare di ultima generazione studiato dai ns. tecnici per consentire una chiusura delle gambe tenace e morbida allo stesso tempo.

Innovative system for opening and closing of the legs designed for professional use.

MODELLO STANDARD CON PROFILI EXTRA A TRE INCLINAZIONI, LA TERZA INCLINAZIONE PERMETTE UN ALLINEAMENTO TOTALMENTE ORIZZONTALE DEL LETTINO. PUÒ ESSERE FORNITO CON O SENZA TETTUCCIO PARASOLE.

SUNBED STANDARD WITH EXTRA PROFILES MODEL WITH 3 INCLINATIONS OF THE BACKREST, THE THIRD INCLINATION RENDERS THE SUN LOUNGER FULLY HORIZONTAL. ALL MODELS CAN BE ORDERED WITH OR WITHOUT SUNSHIELD.

### OPZIONI OPTIONS

FINITURA M  
APERTO  
FINITURA M  
OPEN

MOD. MAXI

RUOTE  
WHEELS

CUSCINO  
CUSHIONS

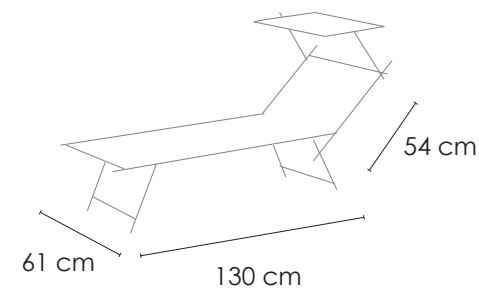

# ≡ LETTINI IN ALLUMINIO ALUMINIUM SUNBEDS

## LETTINO SUPERIOR SUPERIOR SUNBED



HA TRE POSIZIONI, LA TERZA INCLINAZIONE PERMETTE UN ALLINEAMENTO TOTALMENTE ORIZZONTALE DEL LETTINO.

SUNBED WITH 3 INCLINATIONS OF THE BACKREST, THE THIRD INCLINATION RENDERS THE SUN LOUNGER FULLY HORIZONTAL.

OPZIONI OPTIONS	FINITURA M APERTO FINITURA M OPEN	MOD. MAXI	RUOTE WHEELS	CUSCINO CUSHIONS
--------------------	--	-----------	-----------------	---------------------

STANDARD SUPERIOR



MECCANISMO ESCLUSIVO  
A MOLLA CHE CONSENTE  
UN RISTRETTO SPAZIO  
DI STIVAGGIO

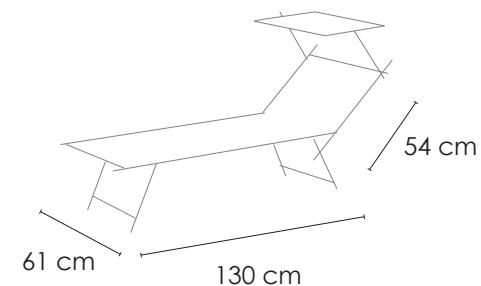

# LETTINI IN ALLUMINIO ALUMINIUM SUNBEDS

## LETTINO 4 POSIZIONI 4 POSIZIONI SUNBED



MECCANISMO SENZA CORDELLA  
WITHOUT STRING



SISTEMA DI MOVIMENTAZIONE BREVETTATO CHE ESCLUDE OGNI POSSIBILITÀ DI SCHIACCIAMENTO ACCIDENTALE DELLE DITA. OFFRE IL VANTAGGIO DI NON AVERE LA CORDELLA PER LA SCELTA DELLA POSIZIONE DI DISTESA PREFERITA.

INNOVATIVE SUNBED WITH 4 INCLINATIONS WITHOUT STRING, OF THE BACKREST, THE FOURTH INCLINATION RENDERS THE SUN LOUNGER FULLY HORIZONTAL. PATENTED SYSTEM.

### OPZIONI OPTIONS

FINITURA S  
CHIUSA  
FINITURA S  
CLOSED

MOD. MAXI

RUOTE  
WHEELS

CUSCINO  
CUSHION IS

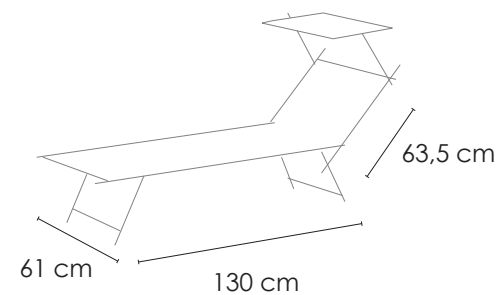

# ≡ LETTINI IN ALLUMINIO ALUMINIUM SUNBEDS

## LETTINO 5 STELLE 5 STELLE SUNBED



MECCANISMO SENZA CORDELLA  
WITHOUT STRING



IL MODELLO A 5 STELLE HA CINQUE DIVERSE INCLINAZIONI DELLO SCHIENALE, DI CUI L'ULTIMA COMPLETAMENTE DISTESA. IL LETTINO È CARATTERIZZATO DALL'INNOVATIVO SISTEMA DI REGOLAZIONE DELLO SCHIENALE BREVETTATO OTTENUTO ATTRAVERSO UN MECCANISMO A CREMAGLIERA. FACILE DA REGOLARE E SENZA CORDICELLA.

THE MODEL HAS FIVE STARS TO 5 DIFFERENT ANGLES OF THE BACK, THE LAST OF WHICH COMPLETELY RELAXED. THE BED IS CHARACTERIZED BY THE INNOVATIVE SYSTEM OF BACKREST ADJUSTMENT IS OBTAINED THROUGH A MECHANISM TO ADJUST PATENT. EASY WITHOUT STRING,

OPZIONI OPTIONS	FINITURA M APERTO FINITURA M OPEN	MOD. MAXI	RUOTE WHEELS	CUSCINO CUSHION IS

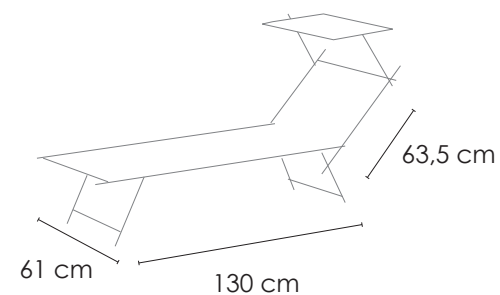



# ≡ LETTINI IN ALLUMINIO ALUMINIUM SUNBEDS

## LETTINO 80 80 SUNBED



MODELLO 80 PRODOTTO ESCLUSIVAMENTE CON SISTEMA A 4 POSIZIONI SENZA CORDELLINO.

INNOVATIVE 80 SUNBED WITH 4 INCLINATIONS WITHOUT STRING, OF THE BACKREST, THE FOURTH INCLINATION RENDERS THE SUN LOUNGER FULLY HORIZONTAL. PATENTED SYSTEM.

OPZIONI  
OPTIONS

RUOTE  
WHEELS

CUSCINO  
CUSHION IS

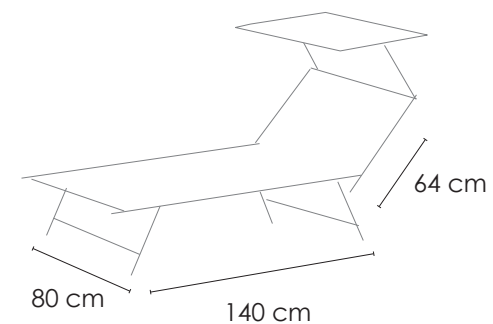

# ≡ LETTINI IN ALLUMINIO ALUMINIUM SUNBEDS

## LETTINO VIP VIP SUNBED



MECCANISMO SENZA CORDELLA  
WITHOUT STRING

MODELLO VIP PRODOTTO ESCLUSIVAMENTE CON SISTEMA A 4 POSIZIONI SENZA CORDELLINO.

INNOVATIVE VIP SUNBED WITH 4 INCLINATIONS WITHOUT STRING, OF THE BACKREST, THE FOURTH INCLINATION RENDERS THE SUN LOUNGER FULLY HORIZONTAL. PATENTED SYSTEM.

OPZIONI  
OPTIONS

RUOTE  
WHEELS

CUSCINO  
CUSHION IS

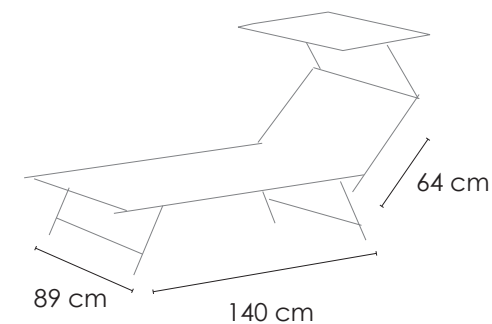

# ≡ LETTINI IN ALLUMINIO ALUMINIUM SUNBEDS

MECCANISMO SENZA CORDELLA  
WITHOUT STRING



## LETTINO SANTORINI SANTORINI SUNBED

LETTINO PARTICOLARMENTE ADATTO A PISCINE E AREE  
RELAX. PERSONALIZZABILE.

DIMENSIONI: 185/206 X L 64 CM H 40 CM

SANTORINI SUNBED IS IDEAL FOR SWIMMING POOL,  
RELAX AREA IN HOTEL

- CUSTOMIZABLE
- EASY REPLACEMENT OF THE CANVAS

DIMENSIONS: 185/206 X 64 CM X H 40 CM

OPZIONI  
OPTIONS

RUOTE  
WHEELS

PARASOLE  
SUNSHIELD



### RUOTE

LE RUOTE SONO APPLICABILI AI LETTINI FACILITANDO-  
NE LO SPOSTAMENTO, SPECIALMENTE IN AREE SPA E  
PISCINE.

### WHEELS

THE WHEELS ARE APPLICABLE TO THE DECK EASIER TO  
MOVE, ESPECIALLY IN AREAS SPA AND SWIMMING  
POOLS.

PARASOLE  
SUNSHIELD



# ≡ LETTINI IN ALLUMINIO ALUMINIUM SUNBEDS

NEWS



MECCANISMO SENZA CORDELLA  
WITHOUT STRING



LETTINO PORTOFINO  
PORTOFINO SUNBED

PORTOFINO

LETTINO IMPILABILE,  
PARTICOLARMENTE ADATTO A PISCINE E AREE RELAX.  
PERSONALIZZABILE.

TELAIO: BIANCO, TALPA, ANTRACITE

DIMENSIONI: 200 X L 79 CM H 40 CM

STACKABLE SUNBED

IT IS IDEAL FOR SWIMMING POOL, RELAX AREA IN HOTEL  
- CUSTOMIZABLE  
- EASY REPLACEMENT OF THE CANVAS

FRAME: WHITE TAUPE, ANTHRACITE

DIMENSIONS: 200 X 79 CM X H 40 CM

RUOTE  
WHEELS



RUOTE  
LE RUOTE CONSENTONO LA MOVIMENTAZIONE DEL  
LETTINO.

WHEELS  
THE WHEELS ALLOW THE MOVEMENT OF THE SUNBED.

≡ LETTINI IN ALLUMINIO  
ALUMINIUM SUNBEDS



LETTINO PORTOFINO  
PORTOFINO SUNBED





## ≡ LETTINI IN ALLUMINIO ALUMINIUM SUNBEDS

### BRANDINA PER CANI SUNBED FOR DOGS

TELO IN PVC E STRUTTURA SUPER RESISTENTE IN ALLUMINIO.  
PERFETTO PER FAR RIPOSARE IL VOSTRO CANE RIALZATO  
DA TERRA.  
DISPONIBILE CON O SENZA PARASOLE.

ALUMINIUM FRAME AND PVC TISSUE FOR THE RELAX OF  
YOUR DOG.  
AVAILABLE WITH OR WITHOUT SUNSHIELD.

DIMENSIONI:  
DIMENSIONS:

H 30 cm  
P 61 cm  
L 100 cm





## ≡ SDRAIO IN ALLUMINIO ALUMINIUM DECKCHAIR



SDRAIO IN ALLUMINIO  
SENZA BRACCIOLI  
REGOLAZIONE INCLINAZIONE  
IN 3 POSIZIONI

DECKCHAIR  
WITHOUT ARMREST  
TILT ADJUSTMENT  
IN 3 POSITIONS

DIMENSIONI:  
DIMENSIONS:

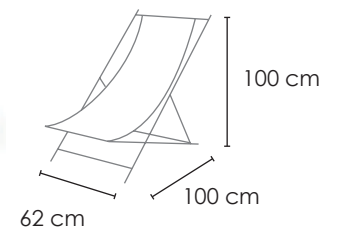

seduta/seating 30/42 cm



≡ SDRAIO IN ALLUMINIO  
ALUMINIUM DECKCHAIR



SDRAIO IN ALLUMINIO CON BRACCIOLI REGOLAZIONE INCLINAZIONE IN 3 POSIZIONI

DECKCHAIR WITH ARMREST TILT ADJUSTMENT IN 3 POSITIONS

DIMENSIONI:  
DIMENSIONS:

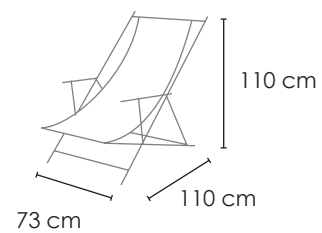

seduta/seating 35/44 cm



≡ SDRAIO IN ALLUMINIO  
ALUMINIUM DECKCHAIR

SDRAIO IN ALLUMINIO  
CON BRACCIOLI A SBALZO  
DECKCHAIR  
WITH ARMREST



REGOLAZIONE INCLINAZIONE IN 3 POSIZIONI

TILT ADJUSTMENT IN 3 POSITIONS

DIMENSIONI:  
DIMENSIONS:

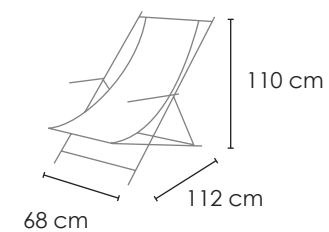

seduta /seating 35/43 cm

# POLTRONCINA E SGABELLO IN ALLUMINIO ALUMINIUM ARMCHAIR AND STOOL

POLTRONCINA MARINELLA E SGABELLO  
MARINELLA ARMCHAIR AND STOOL



REGOLAZIONE INCLINAZIONE IN 2 POSIZIONI

TILT ADJUSTMENT IN 2 POSITIONS

DIMENSIONI:  
DIMENSIONS:

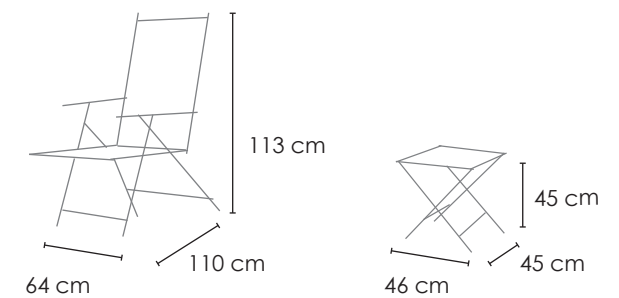

seduta /seating 35/40 cm

# POLTRONCINA REGISTA IN ALLUMINIO ALUMINIUM REGISTA (DIRECTOR'S CHAIR)



VERSIONE ALTA CON PEDANA POGGIAPIEDI  
 HIGH VERSION WITH FOOTREST



VERSIONE ALTA  
 HIGH VERSION



VERSIONE STANDARD  
 STANDARD VERSION

DIMENSIONI:  
 DIMENSIONS:

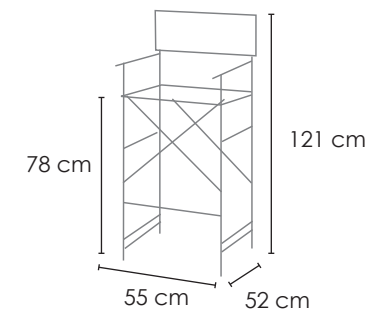
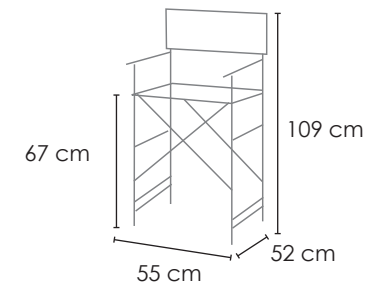
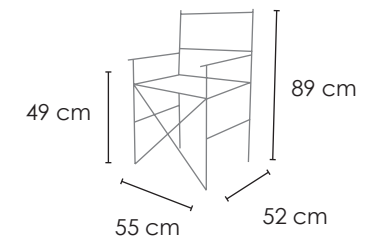

☰ POLTRONCINA AURORA  
AURORA ARMCHAIR

NEWS



DIMENSIONI:  
DIMENSIONS:

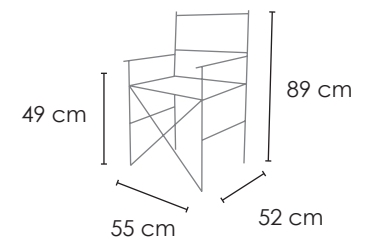

# ≡ POLTRONCINA SAMANTHA SAMANTHA ARMCHAIR

NEWS



POLTRONCINA CON STRUTTURA IN ALLUMINIO VERNICIATO O ANODIZZATO. SEDUTA E SCHIENALE CON TESSUTO MILANO.

ARMCHAIR WITH STRUCTURE IN PAINTED OR ANODIZED ALUMINIUM. SEAT AND BACK IN MILANO FABRIC.

DIMENSIONI:  
DIMENSIONS:

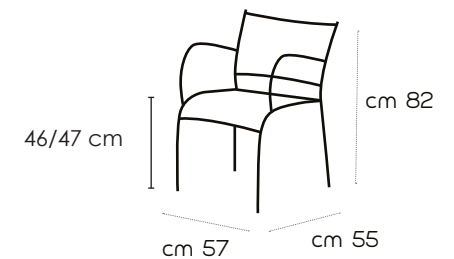

# FINITURE ARTICOLI IN ALLUMINIO ALUMINIUM ARTICLES FINISHES

L'ALLUMINIO DEI NOSTRI ARTICOLI PUÒ  
ESSERE RICHIESTO NELLE SEGUENTI COLORAZIONI:  
THE ALUMINIUM USED IN OUR PRODUCTS IS  
AVAILABLE IN THE FOLLOWING COLOURS:

ANODIZZATO ARGENTO  
ANODIZED ALUMINIUM

VERNICIATO BIANCO  
WHITE PAINTED



- ANODIZZATO ARGENTO (PRODUZIONE STANDARD)  
ANODIZED ALUMINIUM (STANDARD PRODUCTION)

- ANODIZZATO BRONZO (QUANTITATIVO MINIMO RICHIESTO)  
ANODIZED BRONZE (ON DEMAND)

- VERNICIATO NELL'AMPIA GAMMA DI COLORI DISPONIBILI DA SCALA RAL  
(QUANTITATIVO MINIMO RICHIESTO)  
PAINTED IN RAL COLORS AVAILABLE (ON DEMAND)





# ≡ OMBRELLONI BEACH UMBRELLAS

PER TUTTI I NOSTRI ARTICOLI PER STABILIMENTI BALNEARI É POSSIBILE OTTENERE DIVERSI ABBINAMENTI TRA IL TESSUTO ACRILICO PER OMBRELLONI ED IL TESSUTO PLASTIFICATO PER SDRAIO, LETTINI, POLTRONCINE.

FOR ALL OUR ARTICLES FOR BATHING ESTABLISHMENTS, WE CAN SUPPLY DIFFERENT COMBINATIONS BETWEEN THE "MOCRILMARE" MATERIAL FOR THE SUNSHADES AND THE PLASTICIZED MATERIAL FOR THE SUNLOUNGERS, DECKCHAIRS AND ARMCHAIRS.

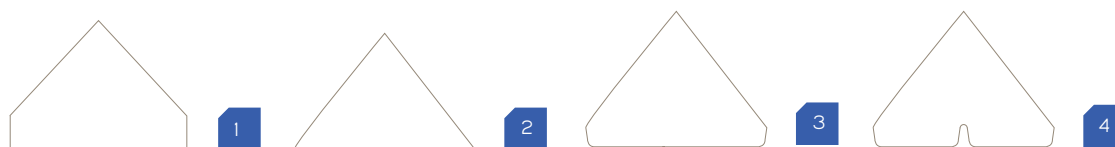

## MANTOVANA OMBRELLONI

- 1 - TRADIZIONALE
- 2 - SENZA MANTOVANA
- 3 - UNA SOLA ONDA
- 4 - ONDE MULTIPLE

## BEACH UMBRELLA VALANCE

- 1 - TRADITIONAL
- 2 - WITHOUT VALANCE
- 3 - SINGLE WAVE
- 4 - MULTIPLE WAVE

PER ZONE ESPOSTE A VENTO DI PARTICOLARE INTENSITÀ, GLI OMBRELLONI POSSONO ESSERE RICHIESTI CON SFIATATOIO.

FOR PARTICULARLY WINDY ZONES, THE SUNSHADES CAN BE SUPPLIED WITH A VENT.

# ≡ OMBRELLONI BEACH UMBRELLAS

## COPERTURA TRADIZIONALE TRADITIONAL BEACH UMBRELLA



COPERTURA TRADIZIONALE SENZA MANTOVANA

PUÒ ESSERE FORNITO CON:

- RAGNO MOD. EGEO, IONIO, SUPERONIO;
- TESSUTO ACRILICO IN TINTA UNITA O A SPICCHI ALTERNATI
- MISURE: 90/10; 100/10; 110/10; 120/10; 130/10
- BORDINO ACRILICO IN TINTA A SCELTA

TRADITIONAL BEACH UMBRELLA WITHOUT VALANCE

CAN BE SUPPLIED WITH:

- FRAME: MOD. EGEO, IONIO, SUPERONIO;
- FABRIC: ACRYLIC IN ONE-COLOUR OR ALTERNATING SEGMENTS
- SIZE: 90/10; 100/10; 110/10; 120/10; 130/10
- ACRYLIC EDGING IN A CHOICE OF COLOURS.



COPERTURA TRADIZIONALE CON MANTOVANA

PUÒ ESSERE FORNITO CON:

- RAGNO MOD. EGEO, IONIO, SUPERONIO;
- TESSUTO ACRILICO IN TINTA UNITA O A SPICCHI ALTERNATI
- MISURE: 80/10; 90/10; 100/10; 110/10; 120/10; 130/10 ;
- BORDINO ACRILICO IN TINTA A SCELTA

TRADITIONAL BEACH UMBRELLA WITH VALANCE

CAN BE SUPPLIED WITH:

- FRAME: MOD. EGEO, IONIO, SUPERONIO;
- FABRIC: ACRYLIC IN ONE-COLOUR OR ALTERNATING SEGMENTS
- SIZE: 80/10; 90/10; 100/10; 110/10; 120/10; 130/10;
- ACRYLIC EDGING IN A CHOICE OF COLOURS.



COPERTURA TRADIZIONALE CON SFIATATOIO

PUÒ ESSERE FORNITO CON:

- RAGNO MOD. EGEO, IONIO, SUPERONIO;
- TESSUTO ACRILICO IN TINTA UNITA O A SPICCHI ALTERNATI
- MISURE: 90/10; 100/10; 110/10; 120/10; 130/10
- BORDINO ACRILICO IN TINTA A SCELTA

TRADITIONAL BEACH UMBRELLA WITH VIND VENT

CAN BE SUPPLIED WITH:

- FRAME: MOD. EGEO, IONIO, SUPERONIO;
- FABRIC: ACRYLIC IN ONE-COLOUR OR ALTERNATING SEGMENTS
- SIZE: 90/10; 100/10; 110/10; 120/10; 130/10
- ACRYLIC EDGING IN A CHOICE OF COLOURS.

# ≡ OMBRELLONI BEACH UMBRELLAS

COPERTURA PAGODINA  
PAGODINA BEACH UMBRELLA



PAGODINA SENZA MANTOVANA

PUÒ ESSERE FORNITO CON:

- RAGNO MOD. IONIO;
- TESSUTO ACRILICO IN TINTA UNITA O A SPICCHI ALTERNATI
- MISURE: 100/10; 110/10; 120/10; 130/10.
- BORDINO ACRILICO IN TINTA A SCELTA

PAGODINA BEACH UMBRELLA WITHOUT VALANCE

CAN BE SUPPLIED WITH:

- FRAME: MOD., IONIO,
- FABRIC: ACRYLIC IN ONE-COLOUR OR ALTERNATING SEGMENTS
- SIZE: 100/10; 110/10; 120/10 ; 130/10
- ACRYLIC EDGING IN A CHOICE OF COLOURS.



PAGODINA CON MANTOVANA

PUÒ ESSERE FORNITO CON:

- RAGNO MOD.IONIO,;
- TESSUTO ACRILICO IN TINTA UNITA O A SPICCHI ALTERNATI
- MISURE: ; 100/10; 110/10; 120/10; 130/10

PAGODINA BEACH UMBRELLA WITH VALANCE

CAN BE SUPPLIED WITH:

- FRAME: MOD.IONIO,
- FABRIC: ACRYLIC IN ONE-COLOUR OR ALTERNATING SEGMENTS
- SIZE: 100/10; 110/10; 120/10 ; 130/10



PAGODINA CON SFIATATOIO

PUÒ ESSERE FORNITO CON:

- RAGNO MOD. IONIO,
- TESSUTO ACRILICO IN TINTA UNITA O A SPICCHI ALTERNATI
- MISURE: ; 100/10; 110/10; 120/10; 130/10
- BORDINO ACRILICO IN TINTA A SCELTA

PAGODINA BEACH UMBRELLA WITH VIND VENT

CAN BE SUPPLIED WITH:

- FRAME: MOD.IONIO,
- FABRIC: ACRYLIC IN ONE-COLOUR OR ALTERNATING SEGMENTS
- SIZE: 100/10; 110/10; 120/10 ; 130/10
- ACRYLIC EDGING IN A CHOICE OF COLOURS.

# ≡ OMBRELLONI BEACH UMBRELLAS

## COPERTURA PAGODA PAGODA BEACH UMBRELLA



PAGODA CON MANTOVANA

PUÒ ESSERE FORNITO CON:

- RAGNO MOD., IONIO,;
- TESSUTO ACRILICO;
- MISURE: ; 100/10; 110/10; 120/10; 130/10
- BORDINO ACRILICO IN TINTA A SCELTA

PAGODA BEACH UMBRELLA WITH VALANCE

CAN BE SUPPLIED WITH:

- FRAME: MOD., IONIO,
- FABRIC: ACRYLIC;
- SIZE: 100/10; 110/10; 120/10 ; 130/10
- ACRYLIC EDGING IN A CHOICE OF COLOURS.



PAGODA CON SFIATATOIO

PUÒ ESSERE FORNITO CON:

- RAGNO MOD., IONIO,
- TESSUTO ACRILICO IN TINTA UNITA O A SPICCHI ALTERNATI;
- MISURE: ; 110/10; 120/10; 130/10
- BORDINO ACRILICO IN TINTA A SCELTA

PAGODA BEACH UMBRELLA WITH VIND VENT

CAN BE SUPPLIED WITH:

- FRAME: MOD., IONIO,
- FABRIC: ACRYLIC, ONE-COLOUR OR ALTERNATING SEGMENTS;
- SIZE: 110/10; 120/10 ; 130/10
- ACRYLIC EDGING IN A CHOICE OF COLOURS.

# ☰ OMBRELLONI BEACH UMBRELLAS

## COPERTURA OMBRELLONI BEACH UMBRELLA



COPERTURA TRADIZIONALE CON FRANGIA

PUÒ ESSERE FORNITO CON:

- RAGNO MOD. IONIO;
- TESSUTO ACRILICO TOTALMENTE RICOPERTO CON RAFIA SINTETICA
- SI PUÒ AVERE NEI COLORI: BIANCO, BEIGE, ROSSO, BLU, VERDE E ARAGOSTA;
- MISURE: 90/10; 100/10; 110/10; 120/10; 130/10.

TRADITIONAL BEACH UMBRELLA WITH FRINGE

CAN BE SUPPLIED WITH:

- FRAME: MOD. IONIO;
- ACRYLIC FABRIC FULLY COVERED WITH A SYNTHETIC RAFFIA FRINGE;;
- AVAILBLE IN COLOURS: WITHE, BEIGE, RED, BLUE, GREEN AND ORANGE.
- SIZE: 90/10; 90/10; 100/10; 110/10; 120/10; 130/10.



BALTICO

COSTRUITO SU TELAIO BALTICO VIENE PRODOTTO SENZA MANTOVANA CON BORDINO. PARTICOLARI PORTASTECCA CON ANGO-LAZIONI STUDIATE PER ACCOGLIERE ADEGUATAMENTE LA STECCA STESSA. DIMENSIONE DISPONIBILE: CM 200X200.

BALTICO

MADE ON BALTICO FRAME, AVAILABLE IN THE MODEL WITH NO VA-LANCE, WITH ACRYLIC EDGING. IT IS SUPPLIED WITH SPECIAL SUP-PORT-RIBS THAT THANKS TO SPECIAL DESIGNED ANGLES ACCOM-MODATE THE RIBS. AVAILABLE SIZE: 200X200.

# ≡ OMBRELLONI BEACH UMBRELLAS

CONFEZIONE OMBRELLONI  
UMBRELLAS PACKAGING

## VITE

SCREW



NEI NOSTRI OMBRELLONI LA COPERTURA VIENE NORMALMENTE FISSATA AI TERMINALI DELLE STECCHE CON VITI INOX E CON PARTICOLARE RINFORZO.

USUALLY, THE COVER OF OUR UMBRELLAS IS SECURED TO THE END OF THE RIBS WITH STAINLESS STEEL SCREWS AND A SPECIAL FABRIC REINFORCEMENT.

## TASCA

POCKET



A RICHIESTA LA COPERTURA VIENE FISSATA CON RINFORZO A FORMA DI TASCA CONTENENTE I TERMINALI DELLE STECCHE.

UPON REQUEST, THE COVER IS HELD IN PLACE BY REINFORCED POCKETS IN WHICH THE END OF THE RIBS IS INSERTED.

# ≡ OMBRELLONI BEACH UMBRELLAS

## COLLANO, CORONA E CAPPELLOTTA IN SPECIALE MATERIALE PLASTICO ANTIUSURA

- 8 STECCHE IN ACCIAIO Ø 5MM  
MISURE: 90/10; 100/10; 110/10; 120/10; 130/10  
EXTRA-PESANTI CON DOPPIE PROTEZIONI MEDIANTE ZINCATURA E SUCCESSIVA PLASTIFICAZIONE CON RIBATTINI DI CONGIUNZIONE AI FORCELLONI IN ACCIAIO INOX
- SISTEMA DI AGGANCIO: DI TIPO INTERCAMBIABILE

## COLLAR, CROWN AND CAP IN SPECIAL WEAR-RESISTANT PLASTIC

- 8 RIBS  
SIZES: 90/10; 100/10; 110/10; 120/10; 130/10  
EXTRA, WITH DOUBLE PROTECTION THROUGH ZINC-COATING AND PLASTICIZING
- FASTENING SYSTEM: INTERCHANGEABLE TYPE

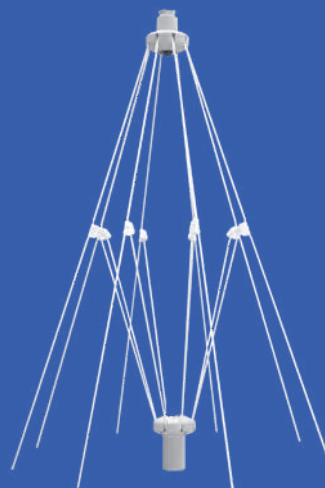

## COLLANO, CORONA E CAPPELLOTTA IN SPECIALE MATERIALE PLASTICO ANTIUSURA CON PULSANTE DI SBLOCCO.

- 10 STECCHE  
MISURE: 90/10; 100/10; 110/10; 120/10; 130/10  
EXTRA-PESANTI CON DOPPIA PROTEZIONE MEDIANTE ZINCATURA E SUCCESSIVA PLASTIFICAZIONE, CON RIBATTINI DI CONGIUNZIONE AI FORCELLONI IN ACCIAIO INOX
- SISTEMA DI AGGANCIO: DI TIPO INTERCAMBIABILE. ATTACCAPANNI ED INNOVATIVO SISTEMA SALVADITO INCORPORATI NEL COLLANO.

## COLLAR, CROWN AND CAP IN SPECIAL WEAR-RESISTANT PLASTIC WITH RELEASE BUTTON.

- 10 RIBS:  
SIZES: 90/10; 100/10; 110/10; 120/10; 130/10  
HEAVY DUTY WITH DOUBLE PROTECTION THROUGH ZINC-COATING AND PLASTICIZING WITH NICKEL-PLATED BRASS RIVETS AT THE JOINTS WITH THE STRETCHERS.
- FASTENING SYSTEM: INTERCHANGEABLE TYPE. CLOTHES HOOKS AND AN INNOVATIVE FINGER PROTECTION SYSTEM INCORPORATED IN THE SLIDER.

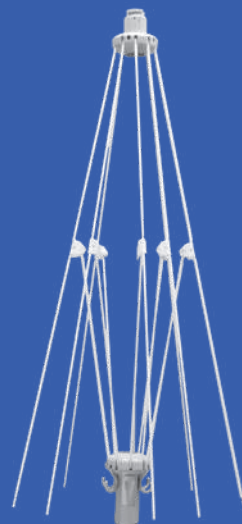

## RAGNI E STECCHE FRAME AND RIBS

### EGEO



### IONIO



\* TOPPA DI PROTEZIONE PER EVITARE IL DETERIORAMENTO DEL TESSUTO. FISSATE CON PARTICOLARI OCCHIELLI IN OTTONE NICKELATO.

PROTECTION PATCH THAT PREVENTS THE FABRIC FROM DETERIORATION. IT IS SECURED WITH SPECIAL NICKEL-PLATED EYELETS.

RAGNI E STECCHE  
FRAME AND RIBS

BALTICO



MAJESTIC



MAJESTIC  
MAJESTIC 2  
Palo Ø 40 mm  
Pole Ø 40 mm



BIG MAJESTIC  
Palo Ø 45 mm  
Pole Ø 45 mm

## ≡ OMBRELLONI BEACH UMBRELLAS



**COLLANO, CORONA E CAPPELOTTO IN SPECIALE MATERIALE PLASTICO ANTIUSURA CON PULSANTE DI SBLOCCO.**

- 8 STECCHE IN ACCIAIO INOX Ø 5MM:  
DA 120 CM  
INSERITE IN COLLANO CON SEDE SPECIFICA PER CREARE UNO SPICCHIO INTERO ED UNO MEZZO.

**COLLANO, CORONA E CAPPELOTTO IN SPECIALE MATERIALE PLASTICO ANTIUSURA CON PULSANTE DI SBLOCCO.**

- 8 RIBS IN Ø 5MM STAINLESS STEEL  
FROM CM 120  
INSERTED IN THEIR SPECIFIC POSITION OF THE COLLAR IN ORDER TO CREATE ALTERNATING WHOLE AND HALF SEGMENTS



**COLLANO, CORONA E CAPPELOTTO IN SPECIALE MATERIALE PLASTICO ANTIUSURA CON PULSANTE DI SBLOCCO.**

- 4 O 8 STECCHE IN ALLUMINIO:  
ATTACCAPANNI ED INNOVATIVO SISTEMA SALVADITO INCORPORATI NEL COLLANO.

**COLLAR, CROWN AND CAP IN SPECIAL WEAR-RESISTANT PLASTIC WITH RELEASE BUTTON**

- 4 OR RIBS IN ALUMINIUM:  
CLOTHES HOOKS AND AN INNOVATIVE FINGER PROTECTION SYSTEM INCORPORATED IN THE COLLAR.



# ≡ OMBRELLONI BEACH UMBRELLAS

## MAJESTIC

OMBRELLONE CON 4 STECCHE RIGIDE ED INTERCAMBIABILI, ADATTO PER PISCINE E HOTEL.

DIMENSIONE: CM 200X200.

BEACH UMBRELLA WITH 4 INFLEXIBLE AND INTERCHANGEABLE RIBS, SUITABLE FOR SWIMMING-POOLS.

SIZE: CM 200X200.



200x200 cm



# ≡ OMBRELLONI BEACH UMBRELLAS

## MAJESTIC 2

OMBRELLONE CON 8 STECCHE RIGIDE E INTERCAMBIABILI,  
PARTICOLARMENTE ADATTO PER PISCINE E SPIAGGE.  
STECCHA IN ALLUMINIO ANODIZZATO E PARTICOLARI IN NYLON.

BEACH UMBRELLA WITH INFLEXIBLE AND INTERCHANGEABLE RIBS,  
SUITABLE FOR SWIMMING-POOL AND BEACH.

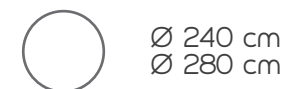

# ≡ OMBRELLONI BEACH UMBRELLAS

## BIG MAJESTIC

OMBRELLONE CON 8 STECCHE RIGIDE ED INTERCAMBIABILI,  
PARTICOLARMENTE ADATTO PER PISCINE E SPIAGGE.  
STECCHA IN ALLUMINIO ANODIZZATO E PARTICOLARI IN NYLON.  
PALO Ø 45 CM

FERMA OMBRELLONE EOLO.  
LE STECCHE SI FISSANO A MEZZO VITE INOX SULLA ROBUSTA PREDISPOSIZIONE  
DEL COLLANO CON FACILITÀ DI SOSTITUZIONE DELLA STECCA.  
DI SERIE CON SFIATATOIO.

BEACH UMBRELLA WITH 8 INFLEXIBLE AND INTERCHANGEABLE RIBS,  
SUITABLE FOR SWIMMING-POOL AND BEACH.

ALUMINIUM ANODIZED RIBS WITH DETAILS IN NYLON.

POLE Ø 45 CM

EOLO UMBRELLA HOLDER.

THE STICKS ARE FIXED BY MEANS OF A STAINLESS STEEL SCREW ON THE STURDY  
PREPARATION OF THE COLLAR WITH EASE OF REPLACEMENT OF THE STICK.  
STANDARD WITH WIND VENT.



Ø 280 cm  
Ø 300 cm



220x220 cm  
300x300 cm



# ≡ OMBRELLONI BEACH UMBRELLAS

## I PALI DELL'OMBRELLONE

ALLUMINIO CON ANODIZZAZIONE ANTICORROSIONE Ø 40 MM.

### **N.B. GENERALMENTE I PALI SONO FISSI.**

SOLO SU RICHIESTA POSSONO ESSERE MUNITI DI **SNODO PER INCLINAZIONE**.

I PALI POSSONO ESSERE FORNITI NELLA **VERSIONE A BAIONETTA O CON FERMAVENTO EOLO**.

## BEACH UMBRELLAS POLE

ALUMINIUM WITH SPECIAL CORROSION-PROOF ANODISING IN DIAMETERS: Ø 40 MM.

### **N.B. THE POLES ARE NORMALLY RIGID.**

ON REQUEST, THE POLES CAN BE FITTED WITH **AN ARTICULATED JOINT FOR TILTING**.

THE POLES CAN BE SUPPLIED IN THE **BAYONET VERSION OR WITH EOLO WIND PROTECTION**.

## PALI OMBRELLONE BEACH UMBRELLAS POLES

PALO  
SUPERIORE  
INNESTO  
BAIONETTA

UPPER POLE  
BAIONETTA  
COUPLING



PALO  
SUPERIORE  
FERMAVENTO  
EOLO

UPPER POLE  
EOLO WIND  
PROTECTION

PALO  
INFERIORE  
INNESTO  
BAIONETTA

LOWER POLE  
BAIONETTA  
COUPLING



PALO  
INFERIORE  
FERMAVENTO  
EOLO

LOWER POLE  
EOLO WIND  
PROTECTION

MISURA DEL PALO INFERIORE: DA 80 CM A 120 CM  
SIZES LOWER POLE FROM 80 CM TO 120 CM

# ACCESSORI ACCESSORIES

ACCESSORI OMBRELLONE  
UMBRELLA ACCESSORIES

## REGGI OMBRELLONE CON TAVOLINETTO

UMBRELLA SUPPORT WITH ROUND TABLE

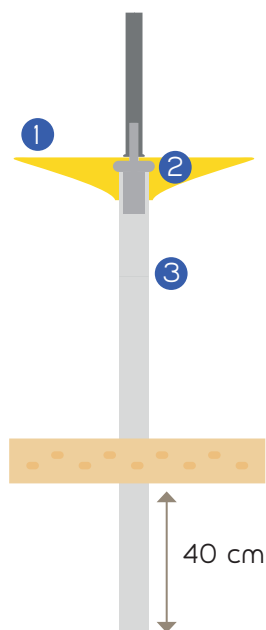

COMPOSTO DA TRE PARTI:  
TAVOLINETTO ROTONDO (COLORI: BEIGE, ARANCIO, GIALLO, VERDE, BLU, BIANCO), COLONNA ESCLUSIVAMENTE BIANCA. GIUNTO DA DIAMETRO 38 - 40 MM O A BAIONETTA. LA COLONNA VA PARZIALMENTE INSERITA NELLA SABBIA E UNA VOLTA UNITA AL GIUNTO, SOSTITUISCE IL PALO INFERIORE DELL'OMBRELLONE.

MADE UP OF THREE PARTS:  
ROUND TABLE (COLOURS: ORANGE, YELLOW, GREEN, BLUE, WHITE, BEIGE) POLE: WHITE ONLY. BAYONET JOINT DIAMETER 38- 40 MM THE HOLDER SHOULD BE PARTIALLY DRIVEN INTO THE SAND, AND ONCE THE JOINT HAS BEEN ADDED, IT SUBSTITUTES THE LOWER PART OF THE SUNSHADE POLE.

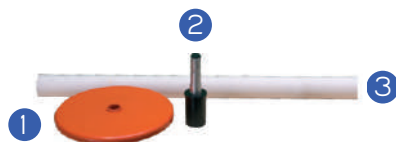

## BLOCCA OMBRELLONE

UMBRELLA LOCK

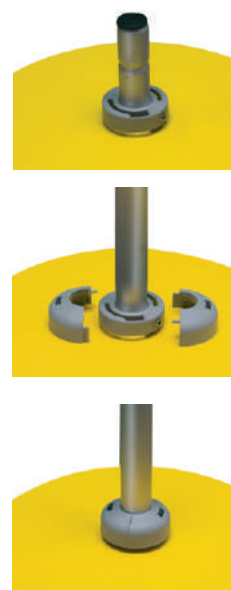

PER TUTTI I TIPI DI OMBRELLONE CHE ABBIANO IL PALO CON BORDO FINALE. E' COMPOSTO DA N°3 ELEMENTI IN MATERIALE PLASTICO DI ALTA QUALITÀ E 2 GRANI IN ACCIAIO INOX. E' LASCIATA ALL'OMBRELLONE LA POSSIBILITÀ DI RUOTARE E QUINDI ANCHE IN CASO DI VENTO PARTICOLARMENTE INSISTENTE, LE STECCHE NON SUBISCONO DANNI COME POTREBBE ACCADERE QUALORA FOSSE IMPOSSIBILITATO A RUOTARE. FACILISSIMO L'ASSEMBLAGGIO ANCHE SU OMBRELLONI USATI.

FOR ALL TYPES OF UMBRELLA POLES WITH A BOTTOM EDGE. THE SYSTEM CONSISTS OF 3 HIGH QUALITY PLASTIC ELEMENTS AND 2 STAINLESS STEEL SCREWS. THE DEVICE ALLOWS THE UMBRELLA TO ROTATE, AS A RESULT THERE IS NO TENDENCY FOR HIGH WINDS TO DAMAGE THE RIBS, WHICH COULD HAPPEN IF THE UMBRELLA IS FIXED. EXTREMELY SIMPLE TO FIT. CAN ALSO BE USED ON EXISTING UMBRELLAS.

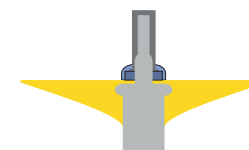

# ACCESSORI ACCESSORIES

ACCESSORI OMBRELLONE  
UMBRELLA ACCESSORIES

## NUMERATORE PER COLONNA

POLE NUMBERS



## NUMERATORE PER PALO

CLIP-ON NUMBERS



## POSACENERE

ASHTRAYS



## COPRI OMBRELLONI

SHEATHS FOR SUNSHADES



MATERIALE: RAFIA SINTETICA  
MATERIAL: SYNTHETIC RAFFIA



## TAVOLINETTO PER COLONNA

TABLES FOR COLUMN

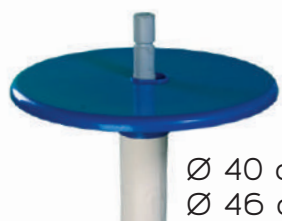

Ø 40 cm  
Ø 46 cm



## TAVOLINETTO IN LEGNO

WOOD SMALL TABLES



## TAVOLINETTO PER PALO

SMALL TABLES FOR SUNSHADES



# ACCESSORI ACCESSORIES

ACCESSORI OMBRELLONE  
BEACH UMBRELLA ACCESSORIES

## PIEDISTALLO OMBRELLONE

PEDESTAL FOR BEACH UMBRELLAS



BASE IN POLIPROPILENE CON CEMENTO (Ø 43 CM), DOTATA DI INNESTO PER PORTA-OMBRELLONE. PESO: 27 KG.

POLYPROPYLENE BASE WITH CEMENT (Ø 43 CM), WITH GRAFT FOR POLE HOLDER. WEIGHT: 27 KG.

## PIEDISTALLO OMBRELLONE RIEMPIBILE

FILLABLE PEDESTAL FOR BEACH UMBRELLAS



BASE RIEMPIBILE DOPPIA SALDATA, COMPLETA DI PORTAOMBRELLONE PER ZONE PARTICOLARMENTE VENTOSE (Ø 43 CM). PESO: 52 KG

BASE FILLABLE, DOUBLE WELDED, COMPLETE WITH POLE HOLDER FOR PARTICULARLY WINDY AREAS (Ø 43 CM). WEIGHT: 52 KG

## PIEDISTALLO OMBRELLONE

PEDESTAL FOR BEACH UMBRELLAS



BASE REGGIOMBRELLONE IN POLIPROPILENE RIEMPITA CON CEMENTO (Ø 54 CM) PESO: 48 KG.

BEACH UMBRELLA SUPPORT BASE IN POLYPROPYLENE WITH CEMENT (Ø 54 CM), WEIGHT: 48 KG.

# ACCESSORI ACCESSORIES

## COLONNA PER GEL IGIENIZZANTE COLUMN FOR SANITIZING GEL

Colonna per gel, guanti e mascherine.  
Disponibile in legno impregnato a bagno  
(utilizzo per esterno) oppure in alluminio.

- pannello per applicazione di un cartello illustrativo formato A4,
- mensola contenitiva per dispenser di gel igienizzante,
- mensola per guanti o mascherine.

Poichè la colonna è internamente vuota, vi è la possibilità di inserire dei pesi ove la stessa risultasse instabile a causa di una pavimentazione non idonea (es. sulla sabbia).

Al posto della mensola porta gel può trovare facile alloggio il dispenser automatico no touch.

Column for gels, gloves and masks in soaked wood (for outdoor use) or in aluminium.

- panel for the application of an A4 format illustrative sign,
- storage shelf for sanitizing gel dispenser,
- shelf for gloves or masks.

Since the column is internally empty, there is the possibility of inserting weights where it is unstable due to unsuitable flooring (ex on sand).

The automatic no touch dispenser can be easily accommodated in place of the gel holder shelf.



LEGNO /  
WOOD  
H 156 cm  
L 45 cm  
P 45 cm



ALLUMINIO /  
ALUMINIUM  
H 176 cm  
L 40 cm  
P 40 cm



## STRUTTURE LEGNO WOOD STRUCTURES

STUDIATE PER ESSERE SMONTATE  
E RIMONTATE FACILMENTE E  
RAPIDAMENTE, SENZA CHE NE  
SIA COMPROMESSA LA STABILITÀ.

LE CABINE VENGONO  
FORNITE SMONTATE CON  
FINITURA GREZZA  
(NON VERNICIATE)  
COMPLETE DI  
PAVIMENTO,  
PANCA DI SEDUTA,  
MENSOLA E  
ATTACCAPANNI.



### CABINE

#### BATHING-HUTS

STRUTTURA AUTOPORTANTE CON TELAIO IN LEGNO IM-  
MASCHIATO ED INCOLLATO COME DA VECCHIA SCUO-  
LA FALEGNAMISTICA.  
DI FACILE ASSEMBLAGGIO.

SELF-SUPPORTING STRUCTURE WITH WOODEN FRAME,  
TAPPED AND GLUED ACCORDING TO THE OLD SCHOOL  
OF CARPENTRY.  
EASY TO ASSEMBLE.

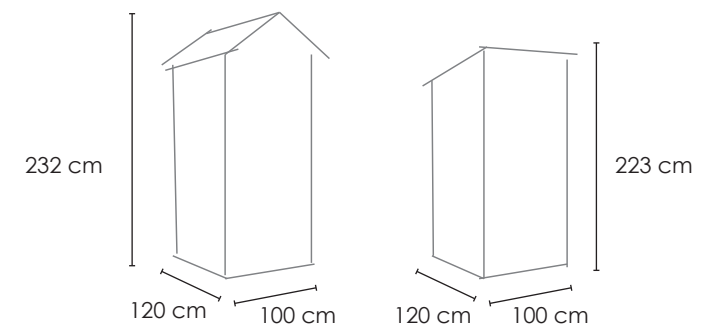

# GAZEBO GAZEBO

GAZEBO IN LEGNO

STRUTTURA IN LEGNO DI ABETE LAMELLARE 10X10 CM, TRAVI ORIZZONTALI 3X7 CM,  
FISSAGGIO MEDIANTE APPOSITO PIEDE IN ACCIAIO INOX.  
TUTTA LA FERRAMENTA È IN ACCIAIO INOX.  
PIASTRE IN ALLUMINIO VERNICIATO SPESSORE 0,5 CM.  
COPERTURA MEDIANTE TESSUTO DI NOSTRA PRODUZIONE.

FRAME MADE OF FIR WOOD 10X10 CM, HORIZONTAL BEAMS 3X7 CM.  
FASTENING BY SPECIAL STAINLESS STEEL FOOT.  
STAINLESS STEEL ACCESSORIES.  
PAINTED ALUMINUM PLATES, THICKNESS 0,5 CM.  
COVER IN PVC TISSUE OF OUR PRODUCTION.

## MISURE STANDARD / STANDARD SIZES

250x250 cm h.220 cm

300x300 cm h.220 cm

a richiesta viene fornito su misura

on request it can be supplied with customized sizes



FINITURE DISPONIBILI/ FINISHES AVAILABLE:

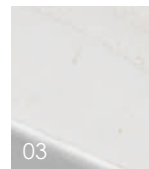

03  
SBIANCATO  
BLEACHED

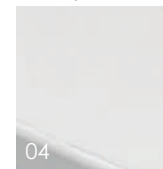

04  
BIANCO PIENO  
FULL WHITE

# GAZEBO GAZEBO

NEWS



## GAZEBO IN ALLUMINIO

GAZEBO IN ALLUMINIO VERNICIATO BIANCO.

GAZEBO IN WHITE PAINTED ALUMINIUM.

MISURE STANDARD / STANDARD SIZES  
300x300 cm h.220 cm

a richiesta viene fornito su misura e in altre colorazioni  
on request it can be supplied  
with customized sizes and in other colors.

FINITURE / FINISHES:



BIANCO  
WHITE

AGGANCIO RAPIDO / QUICK COUPLING:



# ACCESSORI SPIAGGIA BEACH ACCESSORIES

## PORTARIFIUTI

BINS



## ATTREZZATURA PER SPIAGGIA IN ACCIAIO INOX

EQUIPMENT IN STAINLESS STEEL



- 1 - CARRELLO PORTALETTINI;
- 2 - TRIVELLA PER PALO OMBRELLONE;
- 3 - TRIVELLA PER COLONNA;
- 4 - MANICO INOX;
- 5 - VALLO;
- 6 - RASTRELLO SENZA RETE;
- 7 - RASTRELLO CON RETE;
- 8 - RETINO.

- 1 - TROLLEY FOR SUNLOUNGERS;
- 2 - DRILL FOR SUNSHADE POLES;
- 3 - DRILL FOR COLUMNS;
- 4 - STAINLESS STEEL HANDLE;
- 5 - SAND SIEVE;
- 6 - RAKE WITHOUT NET;
- 7 - RAKE WIT
- 8- NET

## TRIVELLONE

DRILL

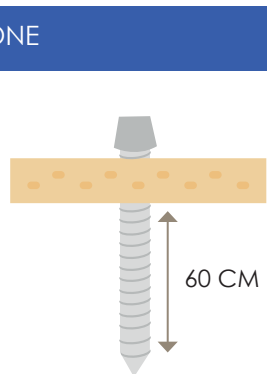

# ACCESSORI SPIAGGIA BEACH ACCESSORIES

## PEDANA IN POLIETILENE

POLYETHYLENE PLATFORM



COLORI DISPONIBILI  
AVAILABLE COLOURS

## PEDANA IN LEGNO

WOOD PLATFORM



CM 50X70  
CM 50X100

MATERIALE:  
POLIETILENE ANTISCIVOLO E STA-  
BILIZZATO AI RAGGI U.V.

OGNI MODULO É CORREDA-  
TO DI APPOSITI GANCI CHE NE  
CONSENTONO L'UNIONE SIA  
DAL LATO LUNGO, SIA DA QUEL-  
LO CORTO. E', PERCIÒ, POSSIBI-  
LE OTTENERE PAVIMENTAZIONI DI  
QUALSIASI DIMENSIONE O PASSE-  
RELLE LARGHE CM. 50 - 70 - 100 E  
CON LUNGHEZZA A PIACERE.

CM. 92,5 X 100 CM

PEDANA MODULARE IN LEGNO  
MONTATA SU 3 BINARI IN ALLU-  
MINIO FISSATA CON APPOSITI RI-  
VETTI. GIUNTI IN NYLON INCLUSI.  
MODULI DI DIMENSIONI DIFFE-  
RENTI A RICHIESTA.

CM 50X70  
CM 50X100

MATERIAL:  
POLYETHYLENE SLIP-RESISTANT  
AND UV-RAYS STABILIZED.

EACH TILE HAS SPECIFIC HOOKS THAT  
ALLOW THE CONNECTION OF THE TI-  
LES BOTH ON THE LONG SIDE AND ON  
THE SHORT SIDE. FOR THIS REASON IT  
IS POSSIBLE TO CREATE PAVINGS OF  
ANY DIMENSION OR BOARDWALKS  
OF A WIDTH OF 50 - 70 - 100 CM AND  
NO LIMITATION OF LENGTH.

CM. 92,5 X 100 CM

MODULAR WOOD PLATFORM MOUN-  
TED ON 3 ALUMINUM RAILS AND SE-  
CURED WITH SPECIFIC RIVETS. NYLON  
JUNCTIONS INCLUDED. MODULES OF  
DIFFERENT DIMENSIONS AVAILABLE  
UPON REQUEST.



# FOTOVOLTAICO PHOTOVOLTAIC

## STAZIONE DI RICARICA MULTIPLA PER SMARTPHONE E PICCOLI ELETTRODOMESTICI A IMPATTO ZERO

**TIRICARICO** È UNA COLONNA FOTOVOLTAICA PER LA RICARICA MULTIPLA DEGLI SMARTPHONE (FINO A 6 CONTEMPORANEAMENTE) E PER L'ALIMENTAZIONE DI PICCOLI ELETTRODOMESTICI IN CORRENTE CONTINUA FINO A 200 W DI POTENZA. L'ENERGIA SOLARE È GENERATA DA UN MODULO SEMI-FLESSIBILE DA 66 WP, COLLEGATO AD UNA APPOSITA UNITÀ OPERATIVA DOTATA DELL'ELETTRONICA "LITHIUM-FREE" BREVETTATA.

L'UNITÀ OPERATIVA GESTISCE LA POTENZA GENERATA DAL MODULO COMPENSANDO EVENTUALI ABBASSAMENTI PERIODICI (AD ESEMPIO IN CASO DI ANNUVOLAMENTO), E ALLUNGA L'AUTONOMIA DEL SISTEMA FINO A 2 ORE IN ASSENZA DI LUCE SOLARE. GLI SMARTPHONE POSSONO ESSERE LASCIATI IN TUTTA SICUREZZA IN APPOSITI ALLOGGIAMENTI CHIUSI A CHIAVE.

### A "ZERO-IMPACT" MULTIPLE CHARGING STATION FOR SMARTPHONES AND SMALL APPLIANCES

TIRICARICO IS A COLUMNAR STATION FOR THE MULTIPLE CHARGE OF SMARTPHONES (UP TO 6 SIMULTANEOUSLY) AND FOR POWERING SMALL HOUSEHOLD DC APPLIANCES (UP TO 200 W). SOLAR ENERGY IS GENERATED BY A 66 WP SEMI-FLEXIBLE MODULE, CONNECTED TO A SPECIAL OPERATING UNIT EQUIPPED WITH PATENTED "LITHIUM-FREE" ELECTRONICS.

THE OPERATING UNIT MANAGES THE POWER GENERATED BY THE MODULE BY COMPENSATING FOR ANY PERIODIC LOWERING (E.G. IN THE EVENT OF CLOUDY WEATHER), AND EXTENDS THE AUTONOMY OF THE SYSTEM UP TO 2 HOURS IN THE ABSENCE OF SUNLIGHT. SMARTPHONES CAN BE SAFELY LEFT IN SPECIAL LOCKED SLOTS.

TIRICARICO



**TIRICARICO**

# FOTOVOLTAICO PHOTOVOLTAIC

LE PERFORMANCE DEL MODULO E DELLA COLONNA DI RICARICA SONO VISUALIZZATE IN TEMPO REALE MEDIANTE UNA APP PER SMARTPHONE DEDICATA, DALLA QUALE L'UTENTE PUÒ ESSERE AGGIORNATO ANCHE SUI SUOI "GREEN GOALS", OSSIA LE RICADUTE EFFETTIVE SULL'AMBIENTE A SEGUITO DELLA SUA SCELTA CONSAPEVOLE DI UTILIZZARE ENERGIA PULITA AL 100% IN ALTERNATIVA A QUELLA PRELEVATA DALLA RETE.  
CON LA SUA TECNOLOGIA A IMPATTO ZERO, È IDEALE PER ALIMENTARE DISPOSITIVI ELETTRONICI IN LUOGHI SOLEGGIATI E LONTANI DALLA PRESA ELETTRICA, COME SPIAGGE O RIFUGI DI MONTAGNA.

THE PERFORMANCE OF THE MODULE AND THE CHARGING COLUMN ARE DISPLAYED IN REAL TIME THROUGH A DEDICATED SMARTPHONE APP, WHERE THE USER CAN ALSO VIEW ON HIS UPDATE "GREEN GOALS", THE ACTUAL EFFECTS ON THE ENVIRONMENT FOLLOWING HIS CONSCIOUS CHOICE TO USE 100% CLEAN ENERGY AS AN ALTERNATIVE TO THE CONVENTIONAL FOSSIL FUELS FROM THE GRID. WITH ITS ZERO-IMPACT TECHNOLOGY, IT IS IDEAL FOR POWERING ELECTRONIC DEVICES IN SUNNY PLACES AWAY FROM THE ELECTRICAL OUTLET, SUCH AS BEACHES OR MOUNTAIN HUTS..

TIRICARICO

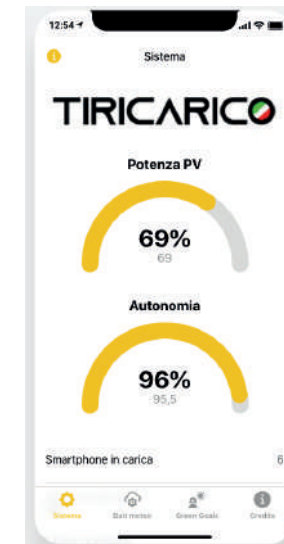

Link all'APP

## FOTOVOLTAICO PHOTOVOLTAIC

**E-RIC** CONSENTE LA RICARICA DEI MEZZI ELETTRICI A DUE RUOTE PIÙ DIFFUSI:

- E-BIKE E BICI A PEDALATA ASSISTITA
- MONOPATTINI ELETTRICI
- SEGWAY
- HOVERBOARD
- E-SCOOTER

**E** COME "MOBILITÀ ELETTRICA" CHE STA INEVITABILMENTE CAMBIANDO IL VOLTO DELLE CITTÀ, RENDENDOLE PIÙ VIVE E VIVIBILI.

**E** COME "EMISSIONI ZERO" LA MOBILITÀ ELETTRICA HA IL PREGIO DI AZZERARE LE EMISSIONI INQUINANTI NELLE CITTÀ. MA LA PRODUZIONE DI ENERGIA ELETTRICA DISPONIBILE IN RETE GENERA COMUNQUE L'EMISSIONE IN ATMOSFERA DI CIRCA 300 G DI GAS SERRA PER OGNI KWH. IL FOTOVOLTAICO AZZERA QUALSIASI TIPO DI EMISSIONE TRASFORMANDO L'ENERGIA ELETTRICA NECESSARIA PER LE RICARICHE IN ENERGIA A ZERO EMISSIONI,

**E** COME "ECOSISTEMA URBANO" LE STAZIONI DI RICARICA GREEN DEVONO ESSERE IMMAGINATE COME UN NUOVO E SEMPRE PIÙ IMPORTANTE ELEMENTO DI ARREDO URBANO.

LA POTENZA DI RICARICA È LA STESSA DELLA RETE ELETTRICA DOMESTICA.



# E-RIC



# FOTOVOLTAICO PHOTOVOLTAIC

E-RIC



**E-RIC** ALLOWS THE RECHARGING OF THE MOST COMMON TWO-WHEELED ELECTRIC VEHICLES:

- E-BIKES AND PEDAL ASSISTED BIKES
- ELECTRIC SCOOTERS
- SEGWAY
- HOVERBOARD
- E-SCOOTER

**E** AS "ELECTRIC MOBILITY" THAT IS INEVITABLY CHANGING THE FACE OF CITIES, MAKING THEM MORE ALIVE AND LIVABLE.

**E** AS "ZERO EMISSIONS", ELECTRIC MOBILITY HAS THE ADVANTAGE OF ELIMINATING POLLUTING EMISSIONS IN CITIES. BUT THE PRODUCTION OF ELECTRICITY AVAILABLE ON THE GRID STILL GENERATES THE EMISSION INTO THE ATMOSPHERE OF ABOUT 300 G OF GREENHOUSE GASES FOR EACH KWH. PHOTOVOLTAIC ELIMINATES ANY TYPE OF EMISSION BY TRANSFORMING THE ELECTRICITY REQUIRED FOR RECHARGING INTO ZERO-EMISSION ENERGY,

**E** AS AN "URBAN ECOSYSTEM" GREEN CHARGING STATIONS MUST BE IMAGINED AS A NEW AND INCREASINGLY IMPORTANT ELEMENT OF URBAN FURNITURE.

THE CHARGING POWER IS THE SAME AS IN THE HOME POWER GRID.



**E-RIC**

## FOTOVOLTAICO PHOTOVOLTAIC

LIBERTA' DI LEGGEREZZA PER LA RICARICA SOLARE DI SMARTPHONE E TABLET

ENERGICO È UN MINI-MODULO FLESSIBILE DA 8 WP PROGETTATO PER RICARICARE ALL'APERTO I PERSONAL DEVICES ALIMENTATI MEDIANTE PRESA USB.  
L'ELETTRONICA DI ENERGICO CONSENTE UNA RICARICA CONTINUA DELLO SMARTPHONE ANCHE IN SITUAZIONI DI IRRAGGIAMENTO SOLARE NON OTTIMALI.  
L'INCAPSULAMENTO BREVETTATO GARANTISCE L'IMPERMEABILITÀ E LA RESISTENZA A LIMITATE DEFORMAZIONI MECCANICHE.

FREEDOM AND LIGHTNESS FOR "SUN-CHARGING" SMARTPHONES AND TABLETS

ENERGICO IS A FLEXIBLE 8 WP MINI-MODULE DESIGNED TO CHARGE USB PERSONAL DEVICES.  
ENERGICO'S ELECTRONICS ALLOW CONTINUOUS CHARGING OF THE SMARTPHONE EVEN IN SITUATIONS OF NON-OPTIMAL SOLAR RADIATION.  
THE PATENTED ENCAPSULATION GUARANTEES WATERPROOFING AND RESISTANCE TO LIMITED MECHANICAL DEFORMATIONS.



**ENERGICO** 



TESSUTI TELE  
FABRIC

LE IMMAGINI DEI CAMPIONI COLORE SONO INDICATIVE E POSSONO SUBIRE VARIAZIONI CROMATICHE.  
THE IMAGES OF COLOR SAMPLES ARE INDICATIVE AND MAY HAVE CHROMATIC VARIATIONS.

# TESSUTI TELE FABRIC

## TRAFORATO RAM

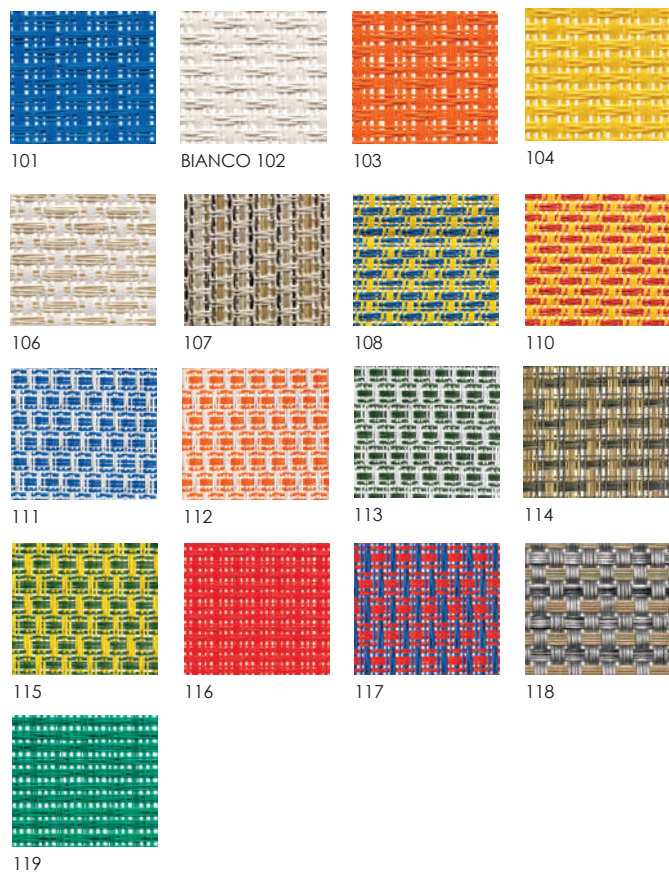

## TRAFORATO COR

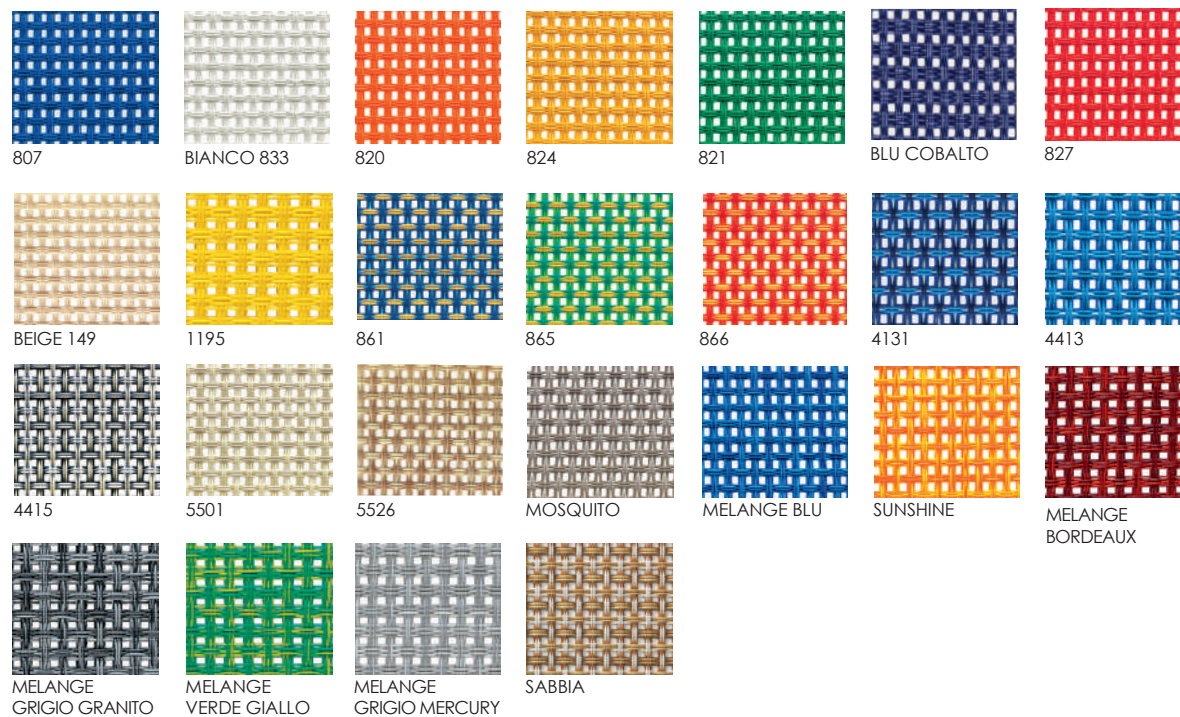

## PARASOLE

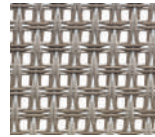

MOSQUITO



TALPA

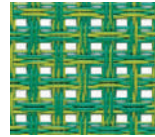

MELANGE VERDE  
GIALLO

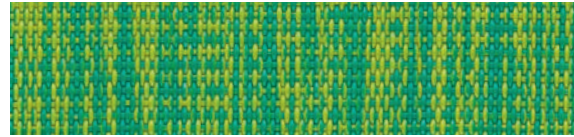

MELANGE VERDE  
GIALLO

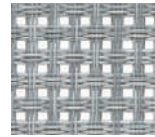

MELANGE  
GRIGIO MERCURY

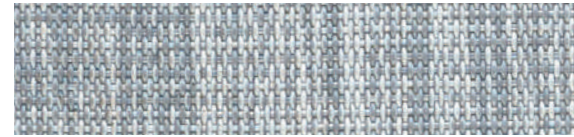

MELANGE  
GRIGIO MERCURY

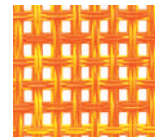

SUNSHINE

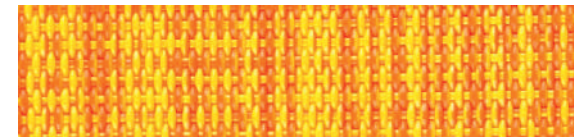

SUNSHINE

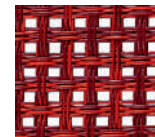

MELANGE  
BORDEAUX

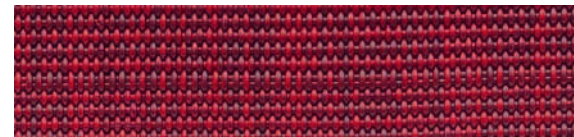

MELANGE  
BORDEAUX

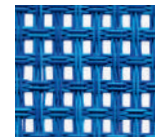

MELANGE BLU

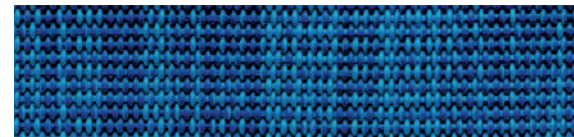

MELANGE BLU

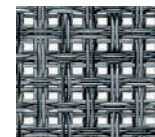

MELANGE  
GRIGIO GRANITO

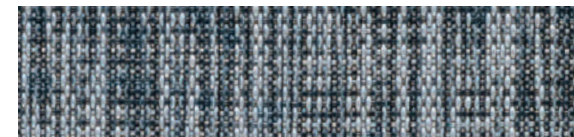

MELANGE  
GRIGIO GRANITO

## LETTINI SDRAIO POLTRONCINE



BIANCO

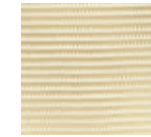

BEIGE



MELANGE BEIGE

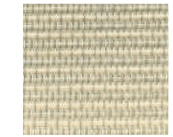

C33

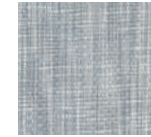

MELANGE  
GRIGIO MERCURY



TALPA

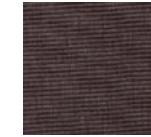

MARRONE TESTA  
DI MORO

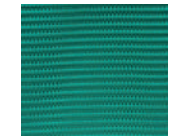

VERDE

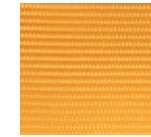

GIALLO

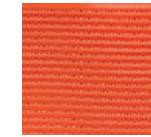

ARANCIO

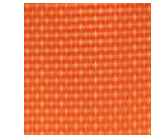

856



ROSSO



MELANGE  
BORDEAUX

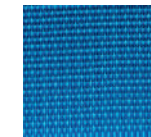

03

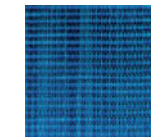

MELANGE BLU

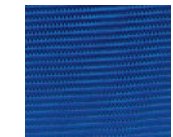

BLU



ROSA

LETTINI SDRAIO POLTRONCINE



840



860



804



841



119



805



842



114



806



846



861



808



843



862



810



800/F



863



847



865



801/F



866



845



867



805/F



803



# OMBRELLONI



# TESSUTI TELE / FABRICs

## PERSONALIZZAZIONI / CUSTOMIZATIONS

GLI OMBRELLONI, I LETTINI, LE SDRAIO E LE POLTRONCINE REGISTA E MARINELLA POSSONO ESSERE PERSONALIZZATE SIA CON SEMPLICE DITURA CON VARI CARATTERI DI STAMPA, SIA CON LA RIPRODUZIONE DEL LOGO DEL CLIENTE CHE PROVVEDERA'AD INVIARCI IN FORMATO VETTORIALE. A FIANCO ALCUNI ESEMPI.

THE SUNSHADES, LOUNGERS, DECKCHAIRS AND CHAIRS IN THE MODEL DIRECTOR AND MARINELLA CAN BE CUSTOMIZED WITH THE NAME OR THE LOGO OF THE BUYER. AS PER THE FOLLOWING EXAMPLES.

Colori disponibili:  
Colours available:









## RIPARAZIONI E RICAMBI MAINTENANCE AND SPARE PARTS

FACCIAMO PRESENTE CHE NEL PERIODO INVERNALE POSSIAMO CURARE **LA MANUTENZIONE DEI PRODOTTI USURATI** PROVVEDENDO AL CAMBIO DELLE TELE DETERIORATE O DANNEGGIATE E DELLA COMPONENTISTICA USURATA.

NATURALMENTE TALE SERVIZIO VIENE SVOLTO SU TUTTA LA PRODUZIONE ILLUSTRATA NEL PRESENTE CATALOGO, IN QUANTO **PRODUTTORI DIRETTI DI TUTTO CIÒ CHE VIENE PROPOSTO.**

NEL CASO, RACCOMANDIAMO UN CONTATTO **ENTRO IL MESE DI SETTEMBRE** PER PROGRAMMARE LA MANUTENZIONE NECESSARIA.

PLEASE NOTE THAT IN WINTER TIME, WE CAN TAKE CARE OF YOUR PRODUCTS PROVIDING AT THE **MAINTENANCE OF DAMAGED ITEMS**, THROUGH THE CHANGE OF THE TISSUE AND THE REPLACEMENT OF THE SPARE PARTS.

OBVIOUSLY, WE CAN PROVIDE MANTENAINCE ON ALL PRODUCTION DESCRIBED IN THIS CATALOGUE, BECAUSE OF **WE ARE THE PRODUCERS OF ALL ITEMS** PROPOSED IN IT.

WE RECOMMEND YOU TO CONTACT US **BY THE END OF SEPTEMBER**, TO SCHEDULE THE NECESSARY MAINTENANCE.



ITALIAN DESIGN



**MIGANI INDUSTRIE s.r.l.**  
via Colombarina, 28/30  
47853 Coriano (RN) - Italy  
tel/fax +39 0541 657213  
[www.migani.it](http://www.migani.it)  
[info@migani.it](mailto:info@migani.it)